

### Description

The AP65550 is an adaptive on-time mode synchronous buck converter providing high efficiency, excellent transient response and high DC output accuracy for low-voltage regulation in digital TV and monitor.

The constant-on-time control scheme handles wide input/output voltage ratios and provides low external component count. The internal proprietary circuit enables the device to adopt both low equivalent series resistance (ESR) output capacitors, such as SP-CAP or POSCAP and ultra-low ESR ceramic capacitors.

The adaptive on-time control supports seamless transition between continuous conduction mode (CCM) at higher load conditions and discontinuous conduction mode (DCM) at lighter load conditions.

DCM allows AP65550 maintain high efficiency at light load conditions. The AP65550 also features programmable soft-start, UVLO, OTP and OCP to protect the circuit.

This IC is available in SO-8EP package.

- Gaming Consoles
- Flat Screen TV Sets and Monitors
- Set Top Boxes
- Distributed Power Systems
- Green Electronics
- Home Audio
- Consumer Electronics
- Network Systems
- FPGA, DSP and ASIC Supplies

### Performance Spec of AP65550SP-EVM (Rev2)

| Parameter             | Conditions  | Performance Value            |
|-----------------------|---|------------------------------|
| Input voltage         | Range 4.5V to 18V                                 | 12V                          |
| Output Current        |   | 5A                           |
| Output Voltage        |   | 1.05V                        |
| Output Voltage Ripple |   | 20mV <sub>P-P</sub>          |
| Transient Response    | Peak-to-peak Deviation<br>Load step from 0A to 5A | 30mV <sub>P-P</sub>          |
| Switching Frequency   |   | 650kHz                       |
| Efficiency            |   | 90%<br>@V <sub>OUT</sub> =5V |

**Figure 1. Evaluation Board (Rev2)**

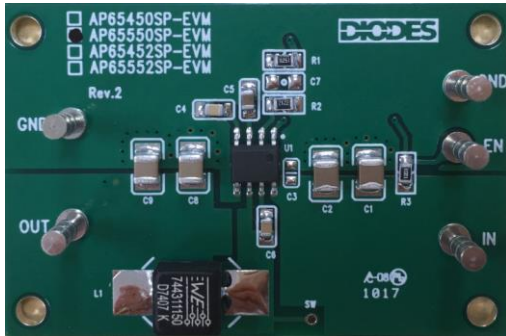

**Figure 2. Load Transient 0 to 5A**

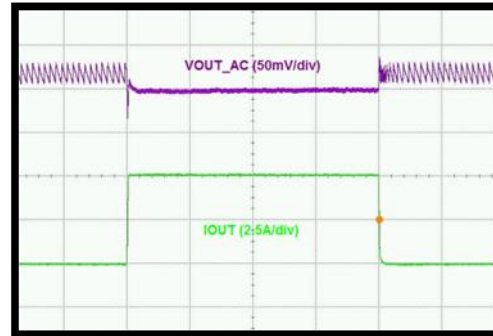

**Figure 3. Efficiency**

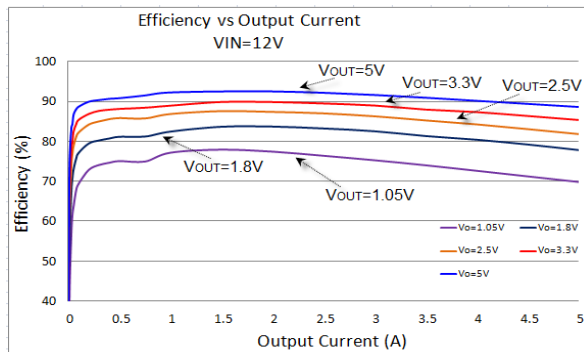

**Figure 4. Light Load Efficiency**

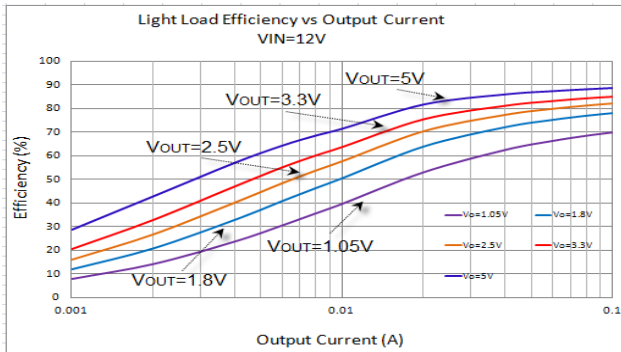

**PCB Layouts**

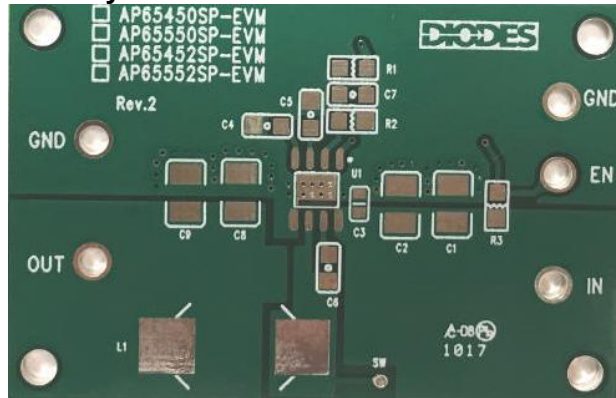

**Top Layer**

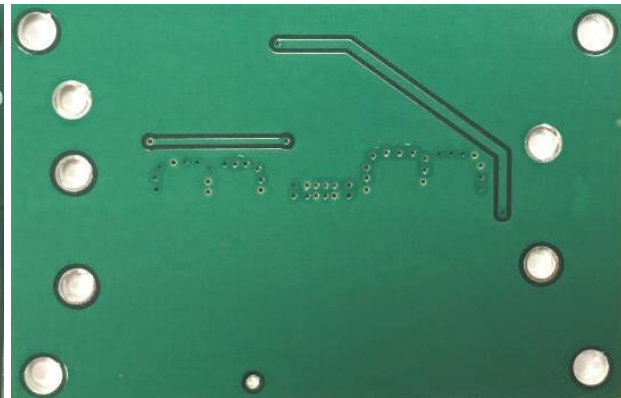

**Bottom Layer**

## Quick Start Guide

The AP65550SP-EVM has a simple layout and allows access to the appropriate signals through test points. To evaluate the performance of the AP65550, follow the procedure below:

1. Connect a power supply to the input terminals  $V_{IN}$  and GND. Set  $V_{IN}$  to 12V.
2. Connect the positive terminal of the electronic load to  $V_{OUT}$  and negative terminal to GND.
3. EN has a positive voltage through a 100K pull-up to  $V_{IN}$ . No supply input is required for EN. Note: To use the EN function drive EN above 1.9V to start the converter and below 0.6V to stop the converter.
4. The evaluation board should now power up with a 1.05V output voltage.
5. Check for the proper output voltage of 1.05V ( $\pm 1\%$ ) at the output terminals  $V_{OUT}$  and GND. Measurement can also be done with a multimeter with the positive and negative leads between  $V_{OUT}$  and GND.
6. Set the load to 5A through the electronic load. Check for the stable operation of the SW signal on the oscilloscope. Measure the switching frequency. A test point is conveniently located at the head of the inductor.

## Measurement/Performance Guidelines:

- 1) When measuring the output voltage ripple, maintain the shortest possible ground lengths on the oscilloscope probe. Long ground leads can erroneously inject high frequency noise into the measured ripple.
- 2) For efficiency measurements, connect an ammeter in series with the input supply to measure the input current. Connect an electronic load to the output for output current.

### EVALUATION BOARD SCHEMATIC

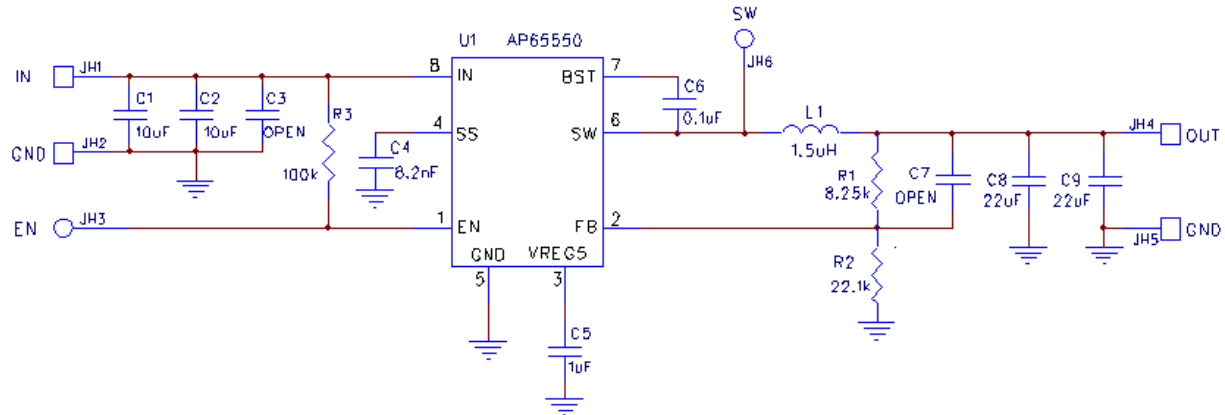

### BILL OF MATERIALS

| REF    | VALUE          | DESCRIPTION                                      | PACKAGE      | MANUFACTURER      | MANUFACTURER P/N |
|--------|----------------|--|--------------|-------------------|------------------|
| C1, C2 | 10 $\mu$ F     | Ceramic Cap, 25V, X7R                            | 1210         | Würth Electronics | 885012209028     |
| C4     | 8.2nF          | Ceramic Capacitor, 16V, X7R                      | 0805         | AVX               | 0805YC822KAT2A   |
| C5     | 1 $\mu$ F      | Ceramic Cap, 16V, X7R                            | 0805         | Würth Electronics | 885012207051     |
| C6     | 0.1 $\mu$ F    | Ceramic Capacitor, 50V, X7R                      | 0805         | Würth Electronics | 885012207098     |
| C8, C9 | 22 $\mu$ F     | Ceramic Cap, 25V, X5R                            | 1210         | AVX               | 12103D226KAT2A   |
| L1     | 1.5 $\mu$ H    | Inductor, SMD<br>6.9mmWx6.9mmLx4mmH              | SMD          | Würth Electronics | 744311150        |
| R1     | 8.25k $\Omega$ | Resistor, 1%                                     | 0805         | Panasonic         | ERJ-6ENF8251V    |
| R2     | 22.1k $\Omega$ | Resistor, 1%                                     | 0805         | Panasonic         | ERJ-6ENF2212V    |
| R3     | 100k $\Omega$  | Resistor, 1%                                     | 0805         | Panasonic         | ERJ-6ENF1003V    |
| T1     | 1598           | Terminal Turret Triple<br>0.094" L (Test Points) | Through-Hole | Keystone Circuit  | 1598-2           |
| U1     |                | DC/DC Converter                                  | SO-8EP       | Diodes Inc        | AP65550SP        |

**IMPORTANT NOTICE**

DIODES INCORPORATED MAKES NO WARRANTY OF ANY KIND, EXPRESS OR IMPLIED, WITH REGARDS TO THIS DOCUMENT, INCLUDING, BUT NOT LIMITED TO, THE IMPLIED WARRANTIES OF MERCHANTABILITY AND FITNESS FOR A PARTICULAR PURPOSE (AND THEIR EQUIVALENTS UNDER THE LAWS OF ANY JURISDICTION).

Diodes Incorporated and its subsidiaries reserve the right to make modifications, enhancements, improvements, corrections or other changes without further notice to this document and any product described herein. Diodes Incorporated does not assume any liability arising out of the application or use of this document or any product described herein; neither does Diodes Incorporated convey any license under its patent or trademark rights, nor the rights of others. Any Customer or user of this document or products described herein in such applications shall assume all risks of such use and will agree to hold Diodes Incorporated and all the companies whose products are represented on Diodes Incorporated website, harmless against all damages.

Diodes Incorporated does not warrant or accept any liability whatsoever in respect of any products purchased through unauthorized sales channel.

Should Customers purchase or use Diodes Incorporated products for any unintended or unauthorized application, Customers shall indemnify and hold Diodes Incorporated and its representatives harmless against all claims, damages, expenses, and attorney fees arising out of, directly or indirectly, any claim of personal injury or death associated with such unintended or unauthorized application.

Products described herein may be covered by one or more United States, international or foreign patents pending. Product names and markings noted herein may also be covered by one or more United States, international or foreign trademarks.

This document is written in English but may be translated into multiple languages for reference. Only the English version of this document is the final and determinative format released by Diodes Incorporated.

**LIFE SUPPORT**

Diodes Incorporated products are specifically not authorized for use as critical components in life support devices or systems without the express written approval of the Chief Executive Officer of Diodes Incorporated. As used herein:

A. Life support devices or systems are devices or systems which:

1. are intended to implant into the body, or
2. support or sustain life and whose failure to perform when properly used in accordance with instructions for use provided in the labeling can be reasonably expected to result in significant injury to the user.

B. A critical component is any component in a life support device or system whose failure to perform can be reasonably expected to cause the failure of the life support device or to affect its safety or effectiveness.

Customers represent that they have all necessary expertise in the safety and regulatory ramifications of their life support devices or systems, and acknowledge and agree that they are solely responsible for all legal, regulatory and safety-related requirements concerning their products and any use of Diodes Incorporated products in such safety-critical, life support devices or systems, notwithstanding any devices- or systems-related information or support that may be provided by Diodes Incorporated. Further, Customers must fully indemnify Diodes Incorporated and its representatives against any damages arising out of the use of Diodes Incorporated products in such safety-critical, life support devices or systems.

Copyright © 2018, Diodes Incorporated

[www.diodes.com](http://www.diodes.com)