

## Table of Contents

<b>Chapter 1. Summary</b> .....	<b>2</b>
1.1 General Description .....	2
1.2 Key Features .....	2
1.3 Applications .....	2
1.4 Main Power Specifications (CV & CC Mode) .....	2
1.5 Evaluation Board Picture: .....	2
<b>Chapter 2. Power Supply Specification</b> .....	<b>3</b>
2.1 Specification and Test Results .....	3
2.1 Transformer Specification.....	4
<b>Chapter 3. Schematic</b> .....	<b>5</b>
3.1 Evaluation Board Schematic .....	5
3.2 Bill of Material (BOM) .....	6
<b>Chapter 4. The Evaluation Board (EVB) Connections</b> .....	<b>7</b>
4.1 Evaluation Board PCB Layout .....	7
4.2 Quick Start Guide Before Connection .....	7
<b>Chapter 5. Testing the Evaluation Board</b> .....	<b>8</b>
<b>5.1 Input &amp; Output Characteristics</b> .....	<b>8</b>
5.1.1 Input Standby Power.....	8
5.1.2 Input Power Efficiency at Different Loading .....	8
5.1.3 OCP Current set point with at different AC line .....	9
5.1.4 PSU Output Characteristics: .....	9
<b>5.2 Key Performance Waveforms:</b> .....	<b>10</b>
5.2.1 System start - up time .....	10
5.2.2 System performance-Voltage Stress .....	10
5.2.3 Short-circuit protection of full load.....	11
5.2.5 System Dynamic Response performance.....	12
<b>5.3 Thermal Test data at room Temperature after running 1 hr</b> .....	<b>13</b>
<b>5.4 System EMI Scan</b> .....	<b>14</b>
5.4.1 System EMI L & N -Line Scan Data @115Vac.....	14
5.4.2 System EMI L & N -Line Scan Data @230Vac.....	15

## Chapter 1. Summary

### 1.1 General Description

The AP3984 stands out as an extremely low standby-power (<10mW) Primary Side Regulation (PSR) switcher for power supplies based on optimal cost-effectiveness, efficiency, Constant Voltage (CV) & Constant Current (CC) accuracy, and versatile protection functions.

The AP3984, with built-in Bipolar Junction Transistor (BJT), regulates the output voltage and current in the primary side by piece-wise Pulse Frequency Modulation (p-PFM) and primary current peak Amplitude Modulation (AM) in discontinuous conduction mode (DCM). The system operating frequency reduces linearly from heavy load to light load in each interval of the p-PFM, and operating frequency is fixed at medium load by varying primary current peak amplitude.

The AP3984 has good transient characteristics in combination with the secondary side IC like AP4341/AP43410 (PSR Accelerator). Typically, minimal voltage of 4.3V at PCB side can be achieved for dynamic test of 5V application system.

The AP3984 provides operating frequency dithering function to improve EMC performance of power supply. The AP3984 also has programmable cable voltage drop compensation function by external resistor.

### 1.2 Key Features

- Primary Side Control for Eliminating Opto-coupler
- Built-in 700V BJT
- Excellent Transient Characteristics
- High Voltage and Super-speed Start up
- External Adjustable Output Cable Voltage Drop Compensation
- Ultra-low No-load Power Consumption(<10mW)
- Multiple PWM/PFM Mode to Improve Audio Noise and Efficiency
- Valley-on for Higher Efficiency and Better EMI
- Multiple Protections:
  - Over Voltage Protection (OVP)
  - Output Short Circuit Protection (SCP)
  - Over Temperature Protection (OTP)
- Totally Lead-free & Fully RoHS Compliant (SO-7)
- Halogen and Antimony Free. "Green" Device

### 1.3 Applications

- Chargers
- Auxiliary Supplies
- Set Top Boxes
- Appliances

### 1.4 Main Power Specifications (CV & CC Mode)

Parameter	Value
<b>Input Voltage</b>	<b>90 to 264V<sub>AC</sub></b>
<b>Input standby power</b>	<b>10mW</b>
<b>Main output Vo / Io</b>	<b>5V / 1A</b>
<b>Efficiency</b>	<b>~ 76%</b>
<b>Total Output Power</b>	<b>5W</b>
<b>Protections</b>	<b>OCP, OVP, OLP, OTP</b>
<b>XYZ Dimension</b>	<b>41x 31 x15 mm</b>
<b>ROHS Compliance</b>	<b>Yes</b>

### 1.5 Evaluation Board Picture:



Figure 1: Top View

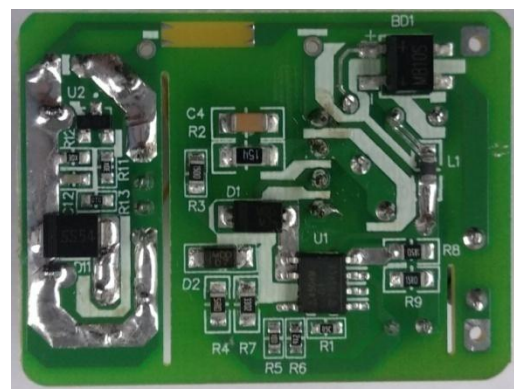


Figure 2: Bottom View

## Chapter 2. Power Supply Specification

### 2.1 Specification and Test Results

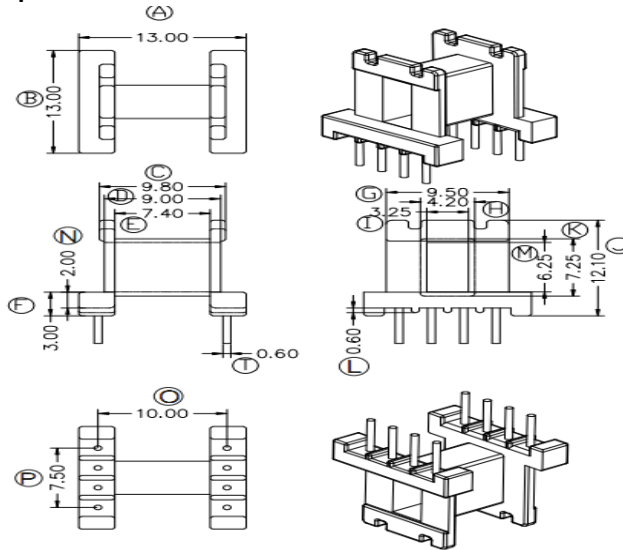
Parameter	Test conditions	Min	Nom	Max	Eff /DOE Level VI	Eff /CoC V5 Tier2	Test Summary
V <sub>ACIN</sub> Input Voltage	-	90 V <sub>RMS</sub>	115/230	264 V <sub>RMS</sub>	-	-	-
F <sub>LINE</sub> Frequency	-	47Hz	50/60	64Hz	-	-	-
I <sub>IN</sub> Input Current	-	-	-	0.13A <sub>RMS</sub>	-	-	Pass
No load Pin	At 230Vac/50Hz, @ 5V, Pin < 10mW	-	-	10mW	-	-	Pass, 230Vac: 6.3mW
5VDC / 1A @115Vac/230Vac Average efficiency	Board end	-	5V/1A	-	73.62%		Pass, 115Vac: 76.5% 230Vac: 76.8%
Thermal Performance	5V-1A @ 90Vac	@AP3984 IC =86.4C @85Vac		@AP3984 IC=88.0C @264Vac			Pass
EMI Scan Data	5V-1A @115Vac		Under Limit line < -6db				Pass
	5V-1A 230Vac		Under Limit line < -6db				Pass

- DoE VI Eff  $\geq 0.0834 \times \ln(P_o) - 0.0014 \times P_o + 0.609$  <V<sub>o</sub><6V
- DoE VI Eff  $\geq 0.071 \times \ln(P_o) - 0.0014 \times P_o + 0.67$  V<sub>o</sub>>6V

## 2.1 Transformer Specification

AP3984 (90V<sub>AC</sub> ~ 265V<sub>AC</sub> one outputs 5W Transformer Spec.)

### 1) Core & Bobbin: EE13, 4+4 pin



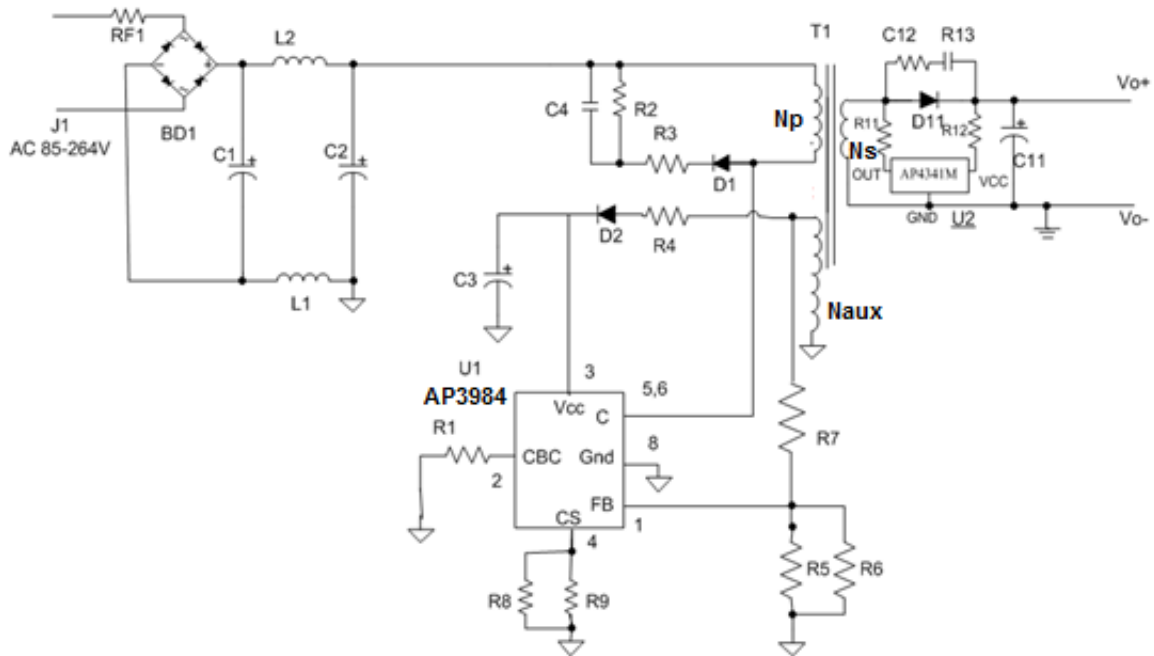
### 2) Transformer Parameters

- Primary Inductance (Pin4-Pin2), all other windings are open  $L_p = 1.75\text{mH} \pm 7\% @ 1\text{kHz}$

EE13 ( $A_e = 17.1\text{mm}^2$ )						
NO Winding	NAME	TERMINAL NO.		WINDING		
		START	FINISH	WIRE	TURNS	Layers
1	Np	4	2	$\Phi 0.14\text{mm} \times 1$	132Ts	1
2	Nfb	3	1	$\Phi 0.15\text{mm} \times 1$	23Ts	3
3	Shield	1	Nc	$\Phi 0.15\text{mm} \times 2$	7.5T	1
4	Ns	B	A	$\Phi 0.5\text{mm} \times 1$	10Ts	1
		1-core				
Primary Inductance		Pin 4-2, all other windings open, measured at 1kHz, 0.4VRMS			1.75mH $\pm$ 7 %	
Primary Leakage Inductance		Pin 4-2, all other windings shorted, measured at 10kHz, 0.4VRMS			80 uH (Max.)	

**Chapter 3. Schematic**

**3.1 Evaluation Board Schematic**



**Figure 3: Evaluation Board Schematic**

## 3.2 Bill of Material (BOM)

Item	QTY per board	REF. DES.	Description	MFG or Supplier	MFG P/N or Supplier P/N Digi key #
1	2	C1,C2	6.8uF/400V, electrolytic	AISHI	
2	1	C3	3.3uF/50V, electrolytic	AISHI	
3	1	C4	1nF/1kV, 1206	MURATA	
4	1	C12	1nF/50V, 0603	MURATA	
5	1	C11	470uF/7.5V, solid state cap	AISHI	
6	1	BD1	MB10S,1000V/0.8A,MBS	Diodes	
7	1	D1	S1M-13-F, rectifier diode, SMA	Diodes	
8	1	D2	S1MWF, rectifier diode,SOD123-FL	Diodes	
9	1	L1	4.7uH , inductor ,1206	TDK	
10	1	L2	330uH, color ring inductor		
11	1	U1	AP3984MTR-G1, SOIC-7	Diodes	
12	1	U2	AP4341SNTR-G1, SOT-23	Diodes	
13	1	FR1	10ohm, 1W		
14	1	D11	Schottky,SS54.5A/40V,SMB	Diodes	
15	1	R1	75kohm, 0603 5%	Yageo	
16	1	R2	150kohm, 1206 5%	Yageo	
17	1	R3	150ohm , 0805 5%	Yageo	
18	1	R4	5.1ohm, 0805,1%	Yageo	
19	1	R5	150kohm, 06031%	Yageo	
20	1	R6	9.1kohm, 0603 1%	Yageo	
21	1	R7	33kohm, 0805 1%	Yageo	
22	1	R8	1.5ohm, 0805 1%	Yageo	
23	1	R9	15ohm, 0805 1%	Yageo	
24	1	R11	20ohm, 0603 5%	Yageo	
25	1	R12	20ohm, 0603 5%	Yageo	
26	1	R13	51ohm, 0603 5%	Yageo	
27	1	T1	EE13 core, PC40, transformer		
28	1	USB	Horizontal connector		

## Chapter 4. The Evaluation Board (EVB) Connections

### 4.1 Evaluation Board PCB Layout

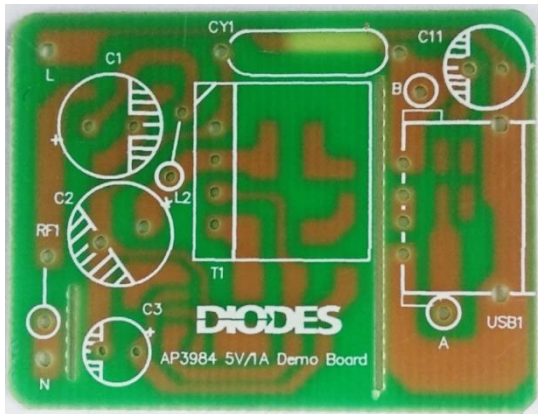


Figure 4: PCB Board Layout Top View

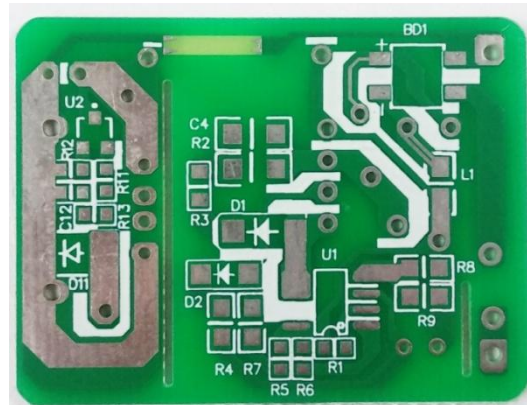


Figure 5: PCB Board Layout Bottom View

### 4.2 Quick Start Guide Before Connection

1. The evaluation board is preset at 5V/1A from output + & -
2. Ensure that the AC source is switched OFF or disconnected before doing connection.
3. Connect the AC line wires of power supply to "L and N" on the left side of the board.
4. Turn on the AC main switch.
5. Measure Red & Black wires to ensure correct output voltages at 5V respectively.

## Chapter 5. Testing the Evaluation Board

### 5.1 Input & Output Characteristics

#### 5.1.1 Input Standby Power

Input Voltage	115Vac/60Hz	230Vac/50Hz	Note
Pin (w)	3.5mW	6.3mW	At no loading

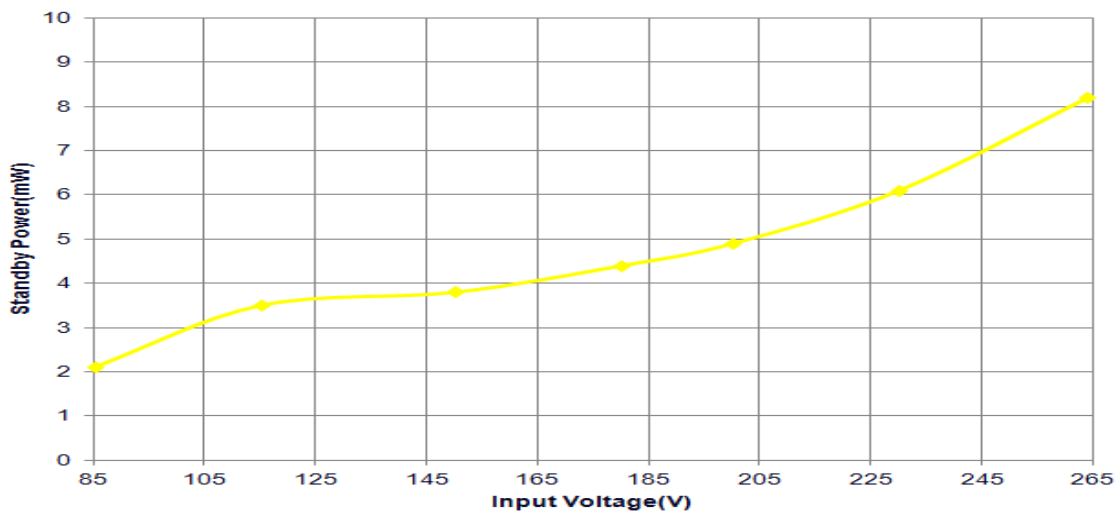


Figure 6: The Efficiency curve with at different AC input

#### 5.1.2 Input Power Efficiency at Different Loading

AC input	Efficiency (%)					Avg. Efficiency
	10%	25%	50%	75%	100%	
90VAC/60Hz						75.13
115VAC/60Hz	72.63%	76.79%	76.6%	76.47 %	76.30%	76.54%
230VAC/50Hz	68.21%	75.3%	76.94%	77.35%	77.5%	76.77%
264VAC/50Hz						77.59%
Avg. Efficiency						



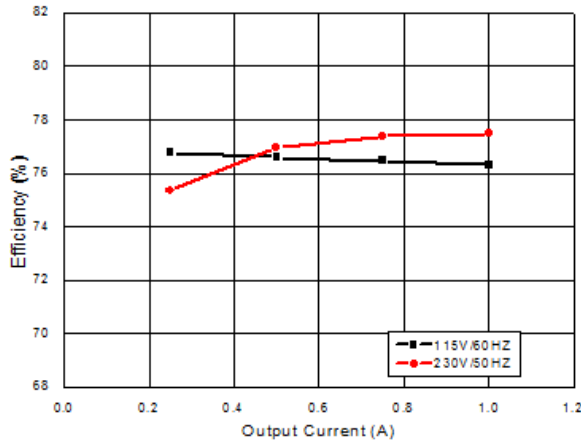


Figure 7: The efficiency curve with different loading

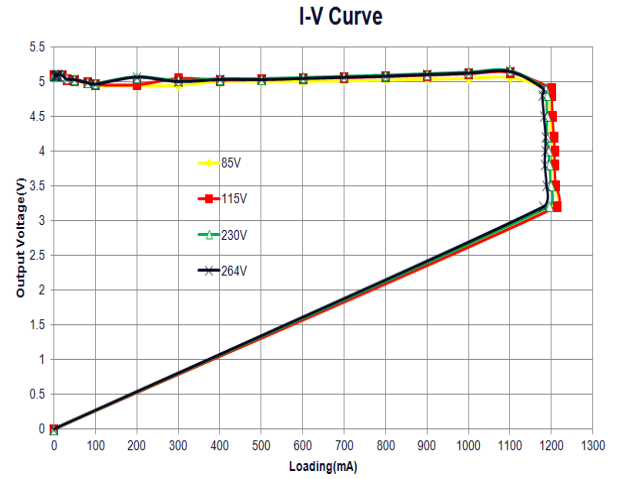


Figure 8: CV & CC Curve at OCP set points

### 5.1.3 OCP Current set point with at different AC line

AC input	90VAC	115VAC	230VAC	264VAC	Note
I_max	1.202A	1.208A	1.194A	1.185A	

### 5.1.4 PSU Output Characteristics:

#### Line Regulation (at full loading condition):

AC input Voltage	90VAC/60Hz	115VAC/60Hz	230VAC/50Hz	265VAC/50Hz	Note
5.00Vo	5.094V/1.0A	5.103V/1.0A	5.117V/1.0A	5.124V/1.0A	0.6%<1%

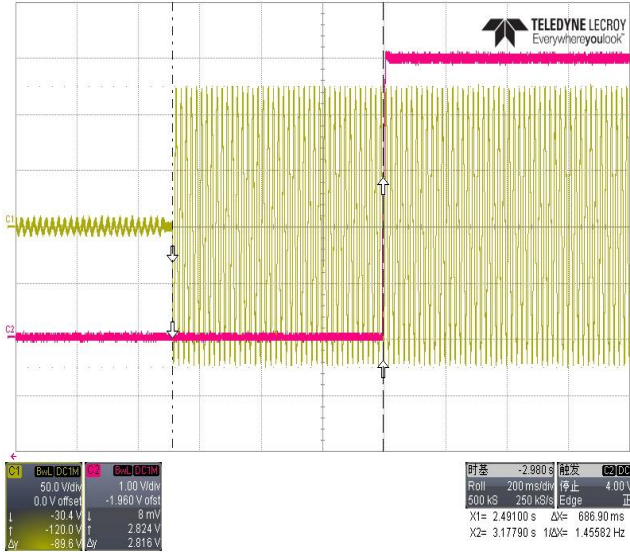
#### Cross Load Regulation (at nominal line AC input voltage):

AC input Voltage	115VAC/60Hz	230VAC/50Hz
5V Full Load	5.103V / 1.0A	5.117V/1.0A
5V 10% of FL	4.957V /0.10A	4.965V/0.10A
Note	2.9%	3.04%

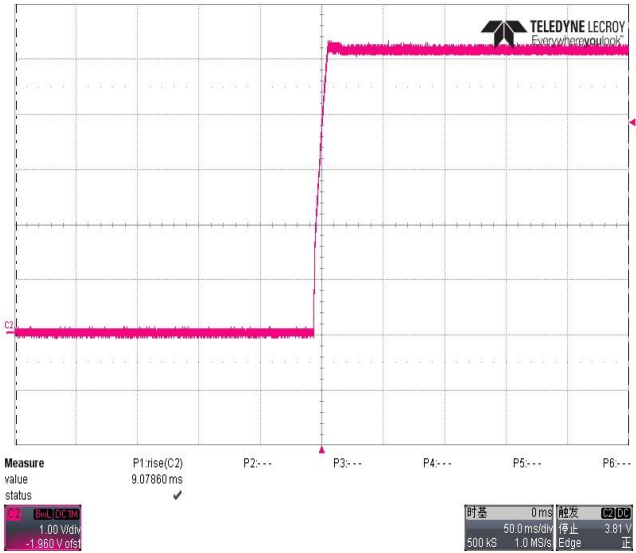
Note: All output voltages are measured at output PCB END.

**5.2 Key Performance Waveforms:**

**5.2.1 System start - up time**

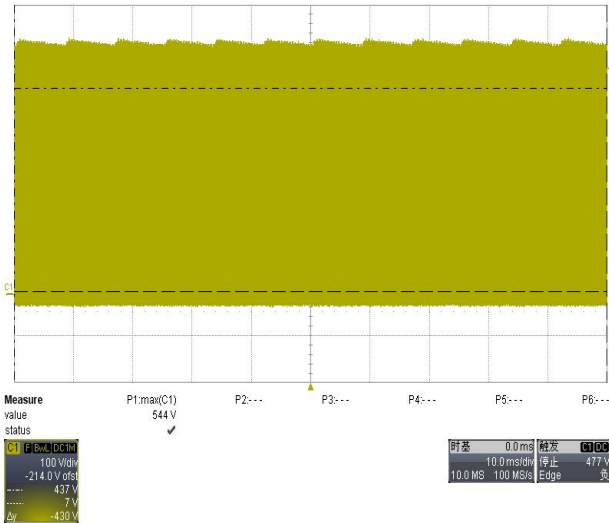


**Figure 9: AP3984 Start up time is 0.68S at 90Vac**

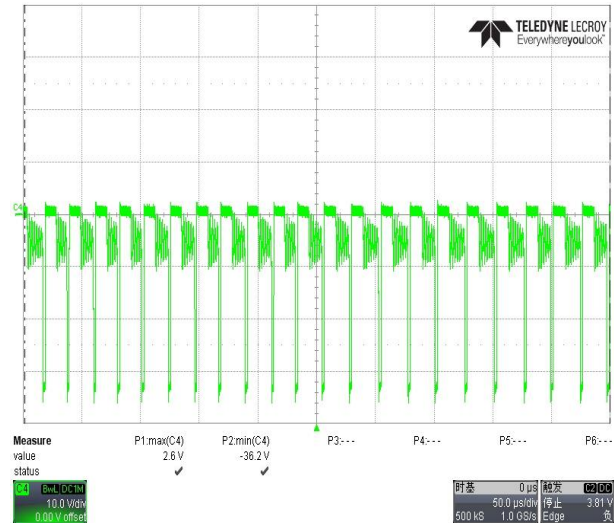


**Figure 10: AP3984 Rising time 9.08mS, at 90Vac**

**5.2.2 System performance-Voltage Stress**



**Figure 11: BJT Q1: Vce=544V;  
264VAC/50Hz, load level: 1A**



**Figure 12: Output schottky: Vak=36.2V;  
264VAC/50Hz, load level: 1A**

**5.2.3 Short-circuit protection of full load**

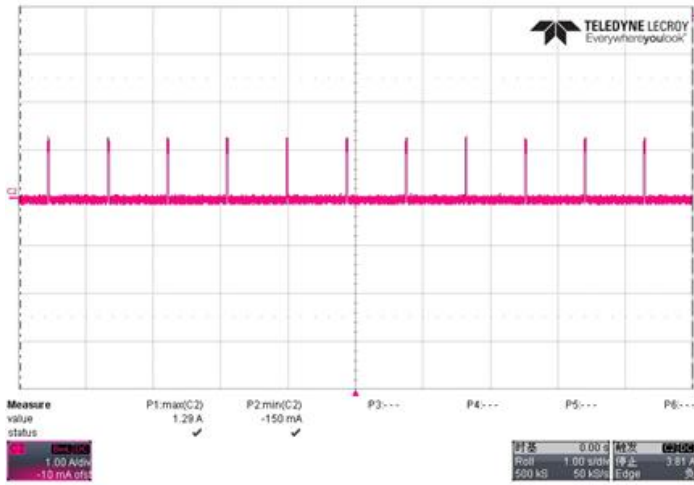


Figure 13:

**90VAC/60Hz, 1.29A  
Pin=8.9mW**

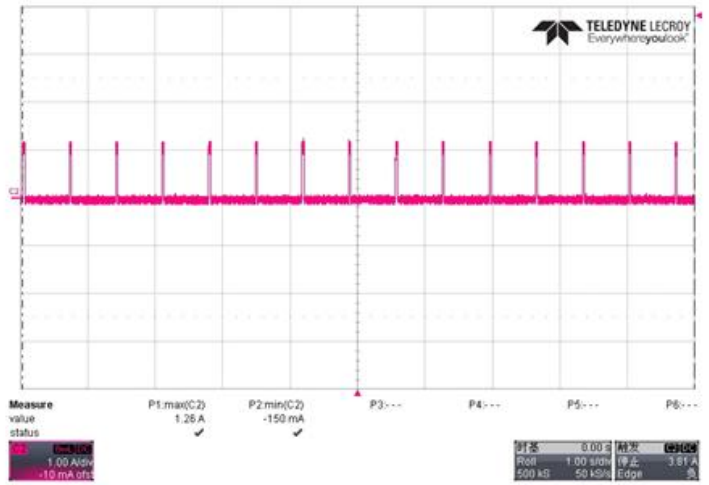


Figure 14:

**264VAC/50Hz, 1.26A  
Pin=130mW**

**5.2.4 System output Ripple performance**

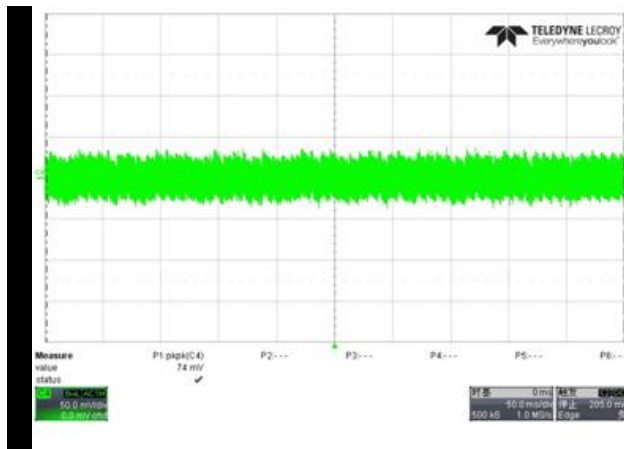


Figure 15: The Ripple at 90Vac\_in Vpp=74mv FL

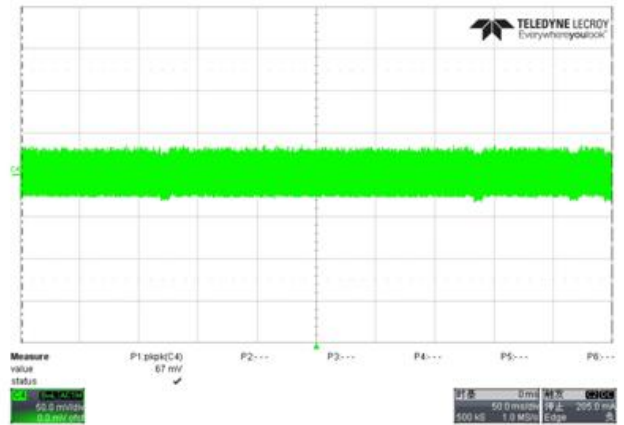
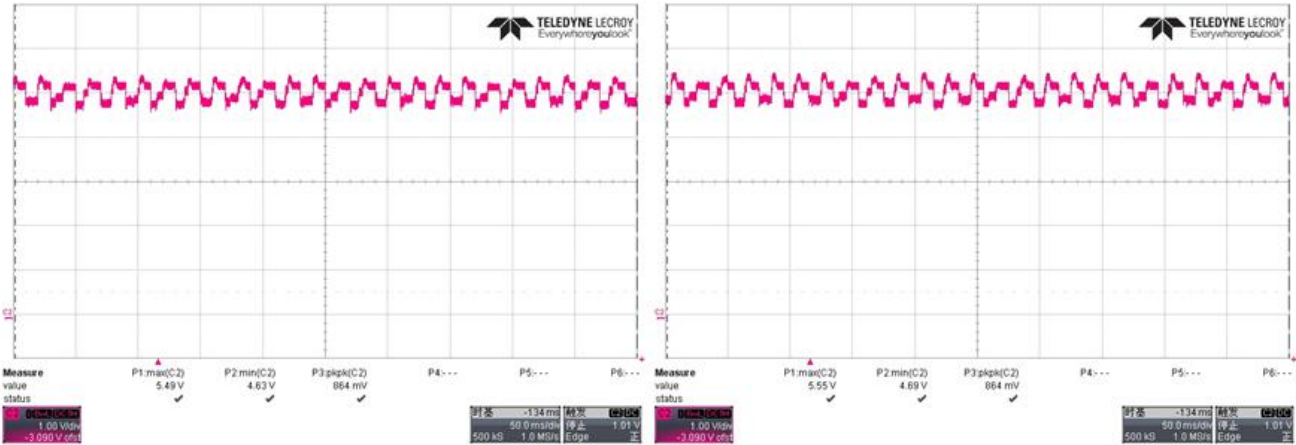


Figure 16: The Ripple at 230Vac\_in Vpp=67mv FL

**5.2.5 System Dynamic Response performance**

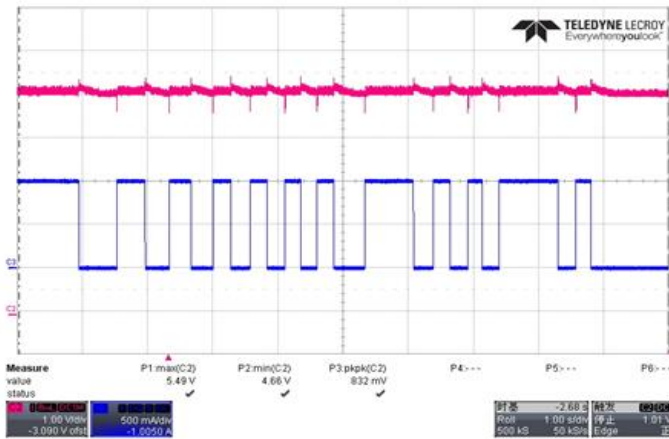


**Figure 17:**

**Vout: 5.55~4.69V**  
**90VAC/50Hz; Load level: 0~1A;**  
**Frequency: 10mS-10mS. Slew rate: 250mA/us**

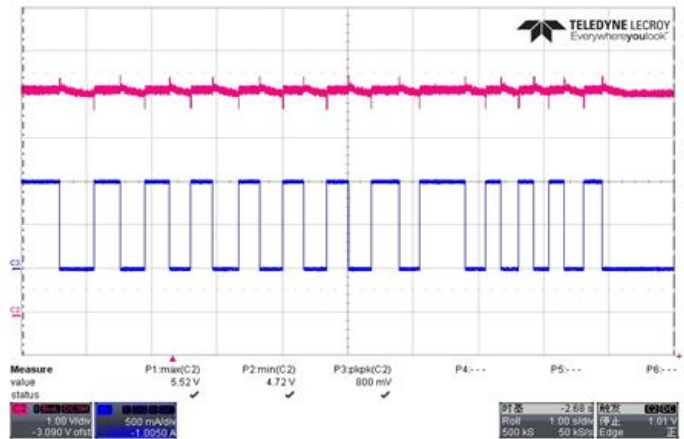
**Figure 18:**

**Vout: 5.55~4.69V**  
**264VAC/50Hz; Load level: 0~1A;**  
**Frequency: 10mS-10mS. Slew rate: 250mA/us**



**Figure 19:**

**Vout: 5.49~4.66V**  
**90VAC/60Hz; Load level: 0~1A;**  
**Frequency: manually. Slew rate: 250A/us**



**Figure 20:**

**Vout: 5.52~4.72V**  
**264VAC/50Hz; Load level: 0~1A;**  
**Frequency: manually. Slew rate: 250A/us**

5.3 Thermal Test data at room Temperature after running 1 hr

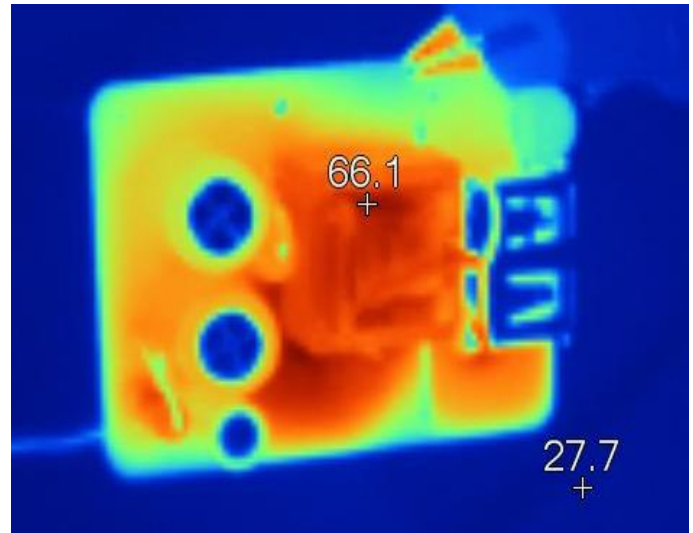


Figure 21:

85Vac/60Hz, 1A	AMB temp: 27.7°C	
IC temp: 73.6°C	Core Temp :66.1 °C	Schottky Temp :74.6°C

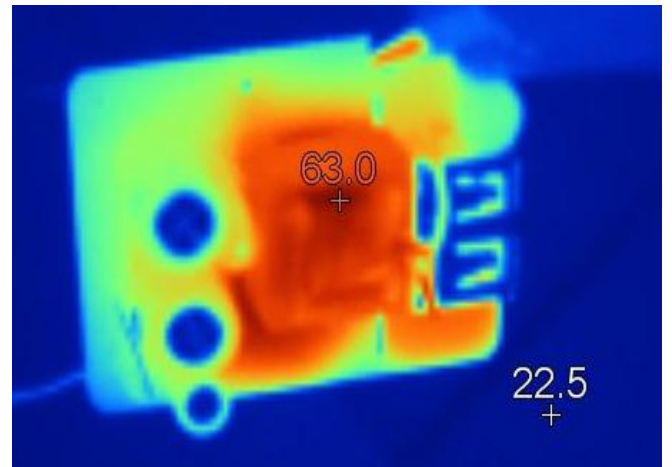
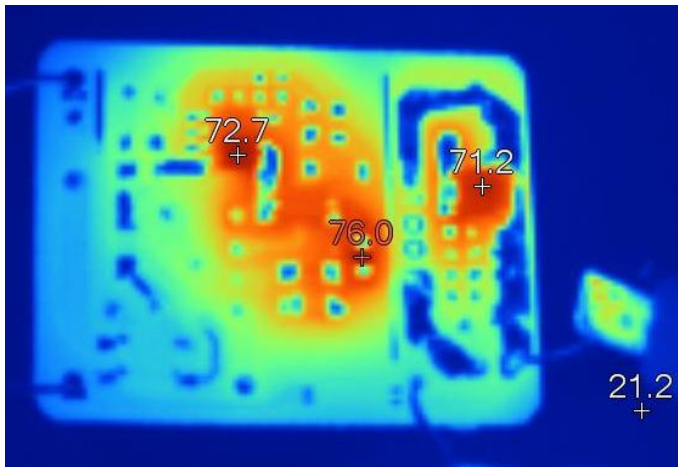


Figure 22:

264Vac/60Hz, 1A	IC temp: 72.7°C	
AMB temp: 22.5°C	Core Temp :63 °C	Schottky Temp :71.2°C



**5.4 System EMI Scan**

**5.4.1 System EMI L & N-Line Scan Data @115Vac**

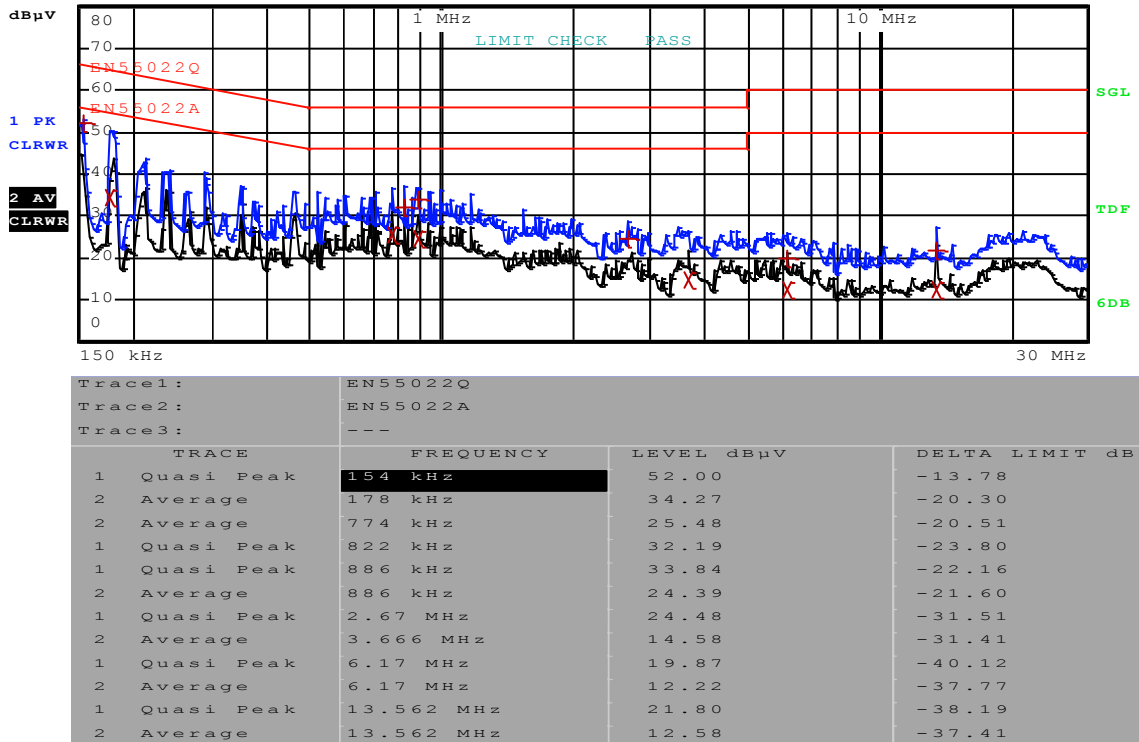


Figure 23: EMI Scan at 115Vac @ L - line

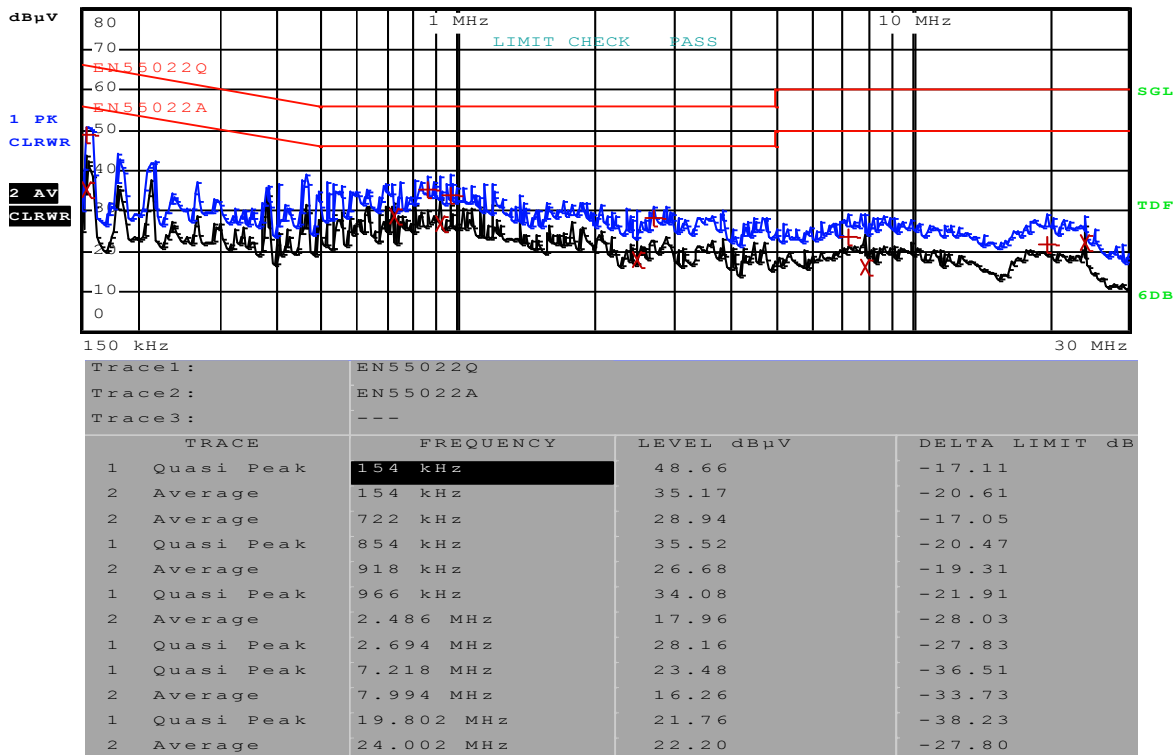
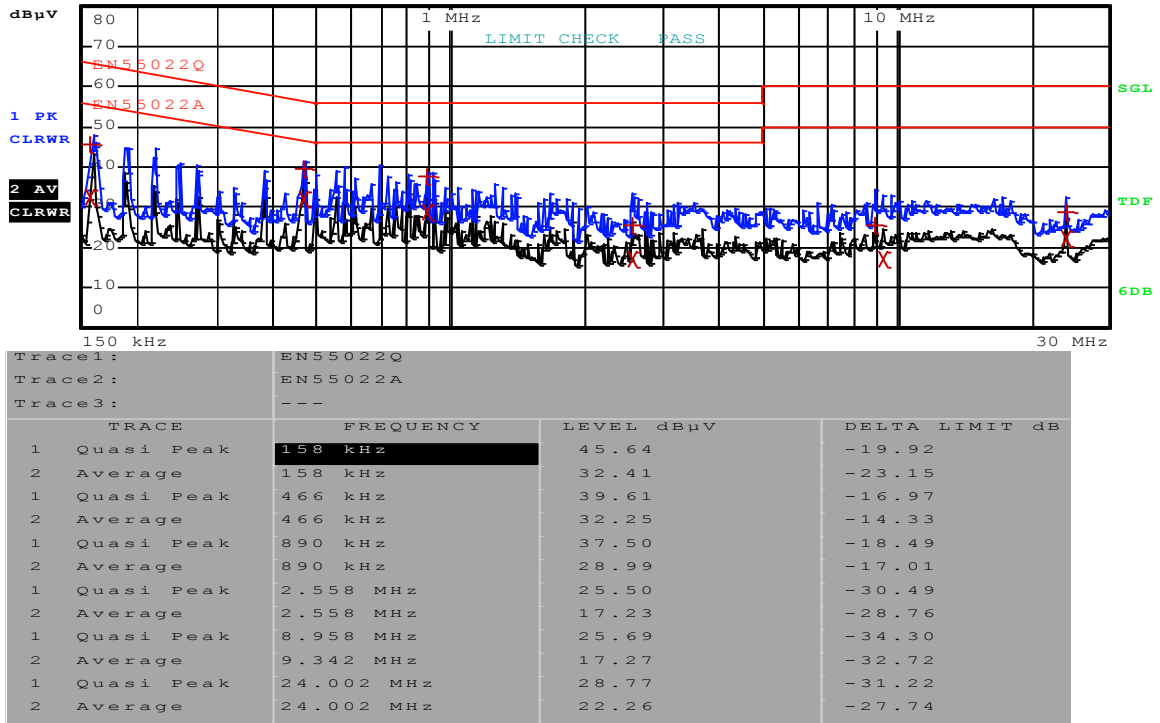
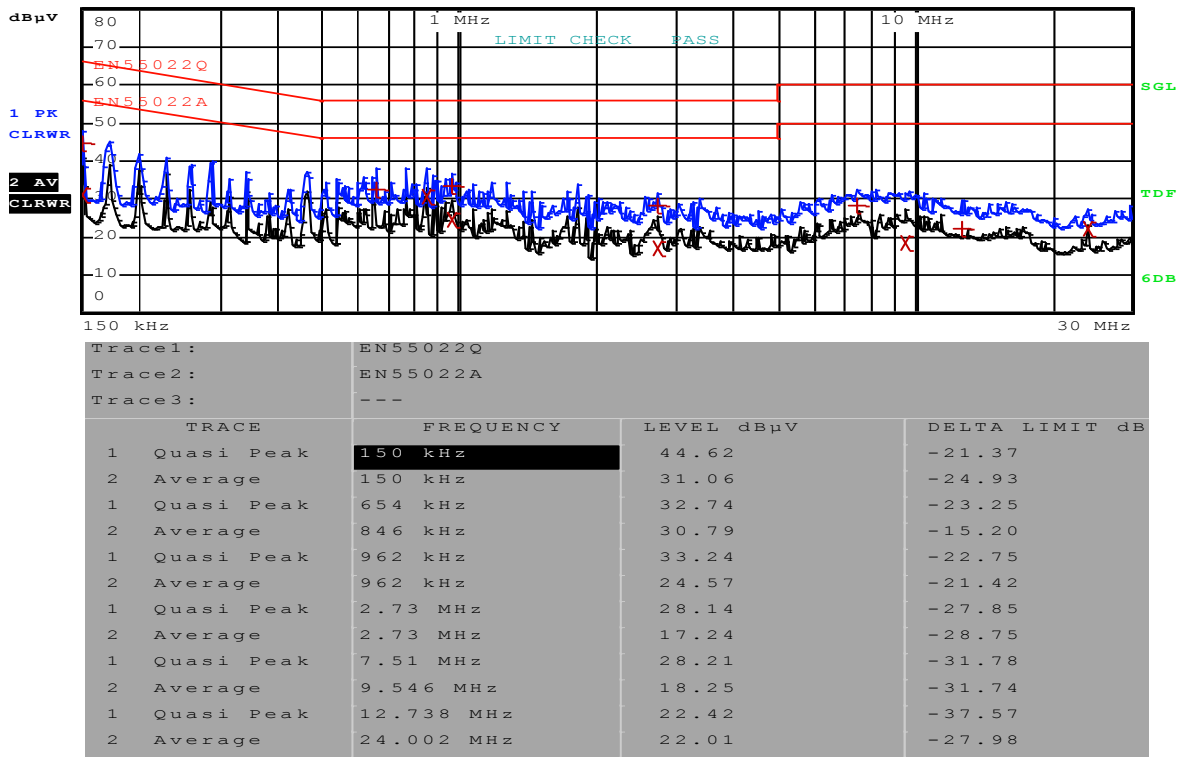


Figure 24: EMI Scan at 115Vac @ N - line

**5.4.2 System EMI L & N-Line Scan Data @230Vac**



**Figure 25: EMI Scan at 230Vac @ L- line**



**Figure 26: EMI Scan at 230Vac @ N - line**

**IMPORTANT NOTICE**

DIODES INCORPORATED MAKES NO WARRANTY OF ANY KIND, EXPRESS OR IMPLIED, WITH REGARDS TO THIS DOCUMENT, INCLUDING, BUT NOT LIMITED TO, THE IMPLIED WARRANTIES OF MERCHANTABILITY AND FITNESS FOR A PARTICULAR PURPOSE (AND THEIR EQUIVALENTS UNDER THE LAWS OF ANY JURISDICTION).

Diodes Incorporated and its subsidiaries reserve the right to make modifications, enhancements, improvements, corrections or other changes without further notice to this document and any product described herein. Diodes Incorporated does not assume any liability arising out of the application or use of this document or any product described herein; neither does Diodes Incorporated convey any license under its patent or trademark rights, nor the rights of others. Any Customer or user of this document or products described herein in such applications shall assume all risks of such use and will agree to hold Diodes Incorporated and all the companies whose products are represented on Diodes Incorporated website, harmless against all damages.

Diodes Incorporated does not warrant or accept any liability whatsoever in respect of any products purchased through unauthorized sales channel.

Should Customers purchase or use Diodes Incorporated products for any unintended or unauthorized application, Customers shall indemnify and hold Diodes Incorporated and its representatives harmless against all claims, damages, expenses, and attorney fees arising out of, directly or indirectly, any claim of personal injury or death associated with such unintended or unauthorized application.

Products described herein may be covered by one or more United States, international or foreign patents pending. Product names and markings noted herein may also be covered by one or more United States, international or foreign trademarks.

This document is written in English but may be translated into multiple languages for reference. Only the English version of this document is the final and determinative format released by Diodes Incorporated.

**LIFE SUPPORT**

Diodes Incorporated products are specifically not authorized for use as critical components in life support devices or systems without the express written approval of the Chief Executive Officer of Diodes Incorporated. As used herein:

A. Life support devices or systems are devices or systems which:

1. are intended to implant into the body, or
2. support or sustain life and whose failure to perform when properly used in accordance with instructions for use provided in the labeling can be reasonably expected to result in significant injury to the user.

B. A critical component is any component in a life support device or system whose failure to perform can be reasonably expected to cause the failure of the life support device or to affect its safety or effectiveness.

Customers represent that they have all necessary expertise in the safety and regulatory ramifications of their life support devices or systems, and acknowledge and agree that they are solely responsible for all legal, regulatory and safety-related requirements concerning their products and any use of Diodes Incorporated products in such safety-critical, life support devices or systems, notwithstanding any devices- or systems-related information or support that may be provided by Diodes Incorporated. Further, Customers must fully indemnify Diodes Incorporated and its representatives against any damages arising out of the use of Diodes Incorporated products in such safety-critical, life support devices or systems.

Copyright © 2016, Diodes Incorporated

[www.diodes.com](http://www.diodes.com)