

General Description

The AL8861Q is a hysteresis mode DC-DC step-down converter, designed for driving single or multiple series connected LEDs efficiently from a voltage source higher than the LED voltage. The device can operate with an input supply voltage from 4.5V to 40V and provide an externally adjustable output current up to 1.5A for MSOP-8EP package. Depending upon supply voltage and external components, this converter can provide up to 40 watts output power.

The AL8861Q integrates the power switch and a high-side output current sensing circuit, which uses an external resistor to set the nominal average output current.

Dimming can be realized by applying an external control signal to the VSET Pin. The VSET Pin will accept either a DC voltage signal or a PWM signal.

The soft-start time can be adjusted by an external capacitor from the VSET Pin to Ground. Applying a voltage of 0.2V or lower to the VSET Pin can turn off the output and make the device enter into standby state with low power consumption.

The AL8861Q has been qualified to AEC-Q100 Grade 1 and is Automotive Grade supporting PPAPs.

Applications

- Automotive Interior LED Lamps
- Automotive Exterior LED Lamps

Key Features

- AEC-Q100 Grade 1 Qualified
- Wide Input Voltage Range: 4.5V to 40V
- Output Current Up to 1.5A
- Internal 40V NDMOS Switch
- Typical 5% Output Current Accuracy
- Single Pin for On/Off and Brightness Control by DC Voltage or
- PWM Signal
- High Efficiency (>95%)
- LED Short-Circuit Protection
- Inherent LED Open-Circuit Protection
- Over Temperature Shutdown
- Up to 1MHz Switching Frequency
- Pb-Free MSOP-8EP Packages
- Totally Lead-Free & Fully RoHS Compliant
- Halogen and Antimony Free. “Green” Device

AL8861QEV1 Specifications

Parameter	Value
Input Voltage	4.5VDC to 40VDC
LED Current	1.5A
Number of LEDs	1~10 LEDs
XYZ Dimension	63mm x 40mm x 10mm

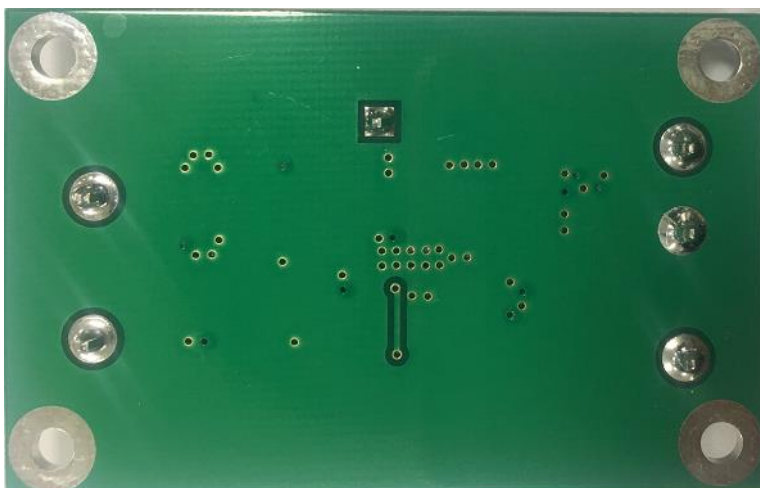
Evaluation Board**Figure 1: Top View****Figure 2: Bottom View****Connection Instructions**

Power Supply Input: 4.5~40VDC (VIN, GND)

VSET: Internal voltage ref. pin (2.5V). This pin can be used to achieve dimming and for switching the output current off. Leave floating for normal operation.

PWM Signal Input: Remove C3, apply PWM signal to VSET (VSET, GND)

Analog Signal Input: Connect 100nF capacitor to C3, apply analog signal to VSET (VSET, GND)

LED A: LED A connects to the external LED anode

LED K: LED K connects to the external LED cathode

Evaluation Board Schematic

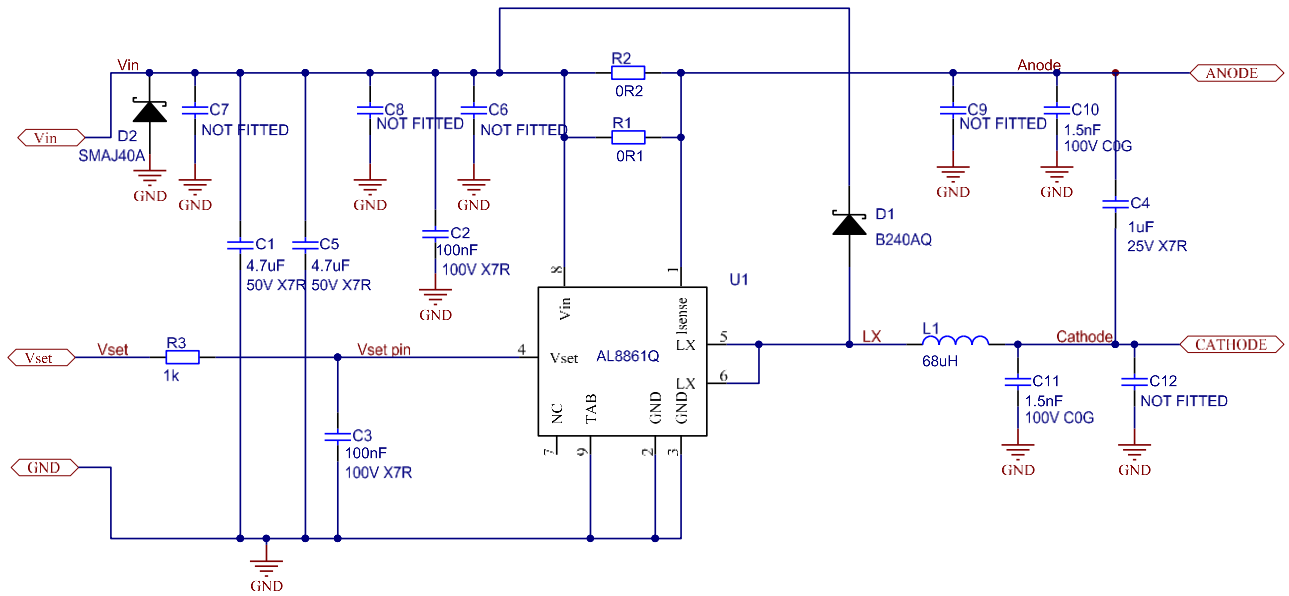

Figure 3: Evaluation Board Schematic

Evaluation Board Layout

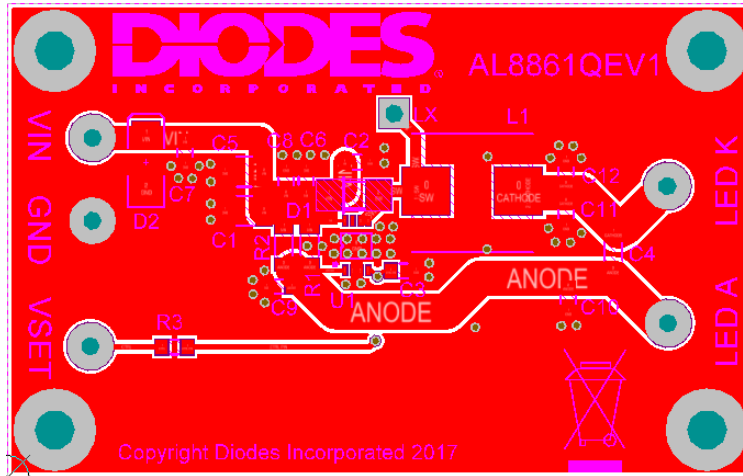

Figure 4: PCB Board Layout Top View

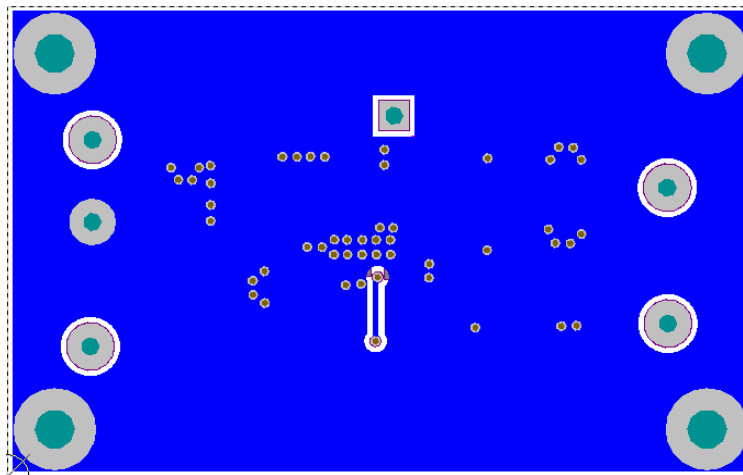

Figure 5: PCB Board Layout Bottom View

Quick Start Guide

1. By default, the evaluation board is preset at 1.5A LED Current by R1 and R2.
2. Non-dimming operation: Leave VSET pin floating for normal operation.
3. Power Supply: Connect the 5~40VDC to VIN & GND pin to supply the system and AL8861Q.
4. PWM Dimming: Remove C4; apply a PWM signal (low level < 0.3V and high level > 2.5) to VSET pin to dim the LEDs. The recommended PWM signal frequency is from 100Hz to 1kHz, and the PWM duty is from 1% to 100%.
5. Analog Dimming: Connect 100nF capacitor to C3; the VSET pin may be driven between 0.3V and 2.5V adjusting the output current from 5% to 100% of I_{LED} .

Bill of Material

Ref	Value	Package	Part Number	Manufacturer	Notes
U1	AL8861Q	MSOP-8EP	AL8861QSP-13	Diodes	DC-DC converter
D1	40V, 2A	SMA	B240AQ-13-F	Diodes	Schottky diode
D2	40V	SMA	SMAJ40A	Diodes	TVS diode
R1	0R100	1206		Generic	+/-1%
R2	0R200	1206		Generic	+/-1%
R3	1K	0805		Generic	+/-5%
C1, C5	4.7 μ F, 50V	1210	C1210X475K5RAC	Generic KEMET	X7R
C2, C3	100nF, 100V	0805	NMC0805X7R104K100	Generic NIC Comps	X7R
C4	1 μ F, 50V	1206	NMC1206X7R105K100	Generic NIC Comps	X7R
C10, C11	1.5nF, 100V	0805		Generic	C0G
C6, C7, C8, C9, C12	Not Fitted	0805			X7R Optional capacitor
L1	68 μ H	1280	7447714680	Würth Elektronik	68 μ H, ~0.1R, ~1.9A

Note: The component part numbers are correct at the time of publication. Diodes Inc reserves the right to substitute other parts where necessary, without further notification.

Functional Waveforms

**Switching waveform(Vin=20V, 3LEDs)
(Y-Vin, R-SW, B-VSET, G-I_L)**

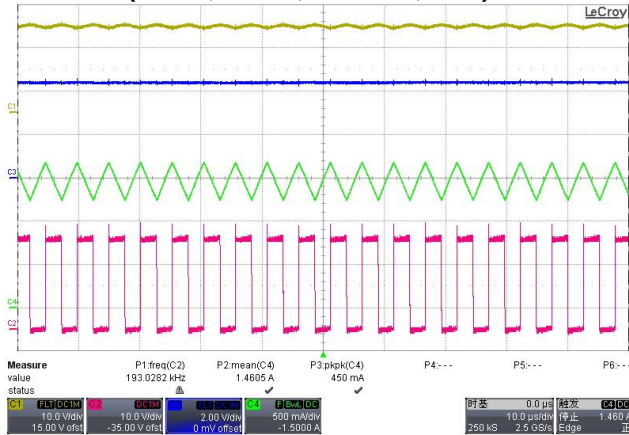

**Start-up waveform(Vin=20V, 3LEDs)
(Y-Vin, R-SW, B-VSET, G-I_L)**

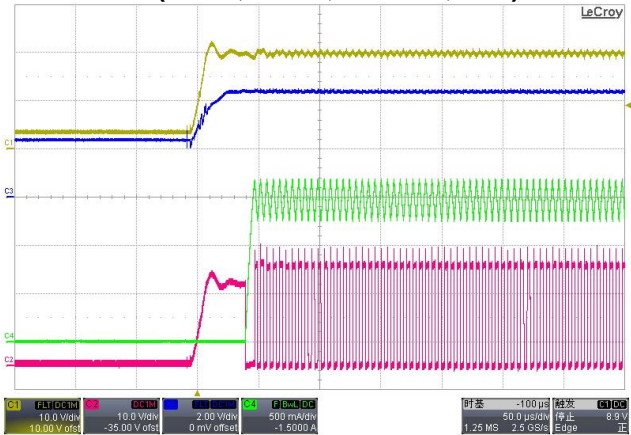

**Soft Start waveform
(Vin=20V, 3LEDs, C4=10nF)
(Y-Vin, R-SW, B-VSET, G-I_L)**

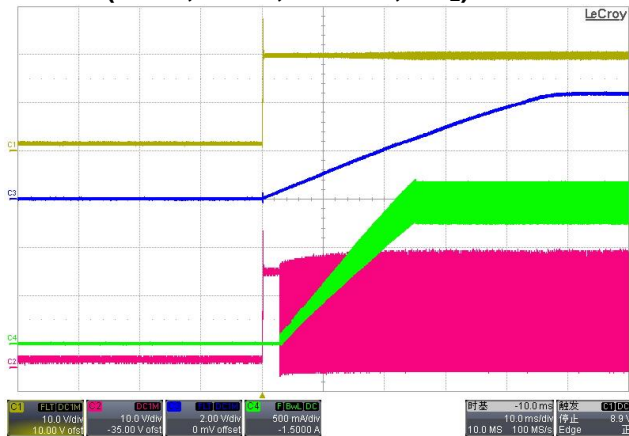

**PWM Dimming waveform(Vin=20V, 3LEDs)
(PWM frequency=500Hz, Duty=80%)
(Y-Vin, R-SW, B-VSET, G-I_L)**

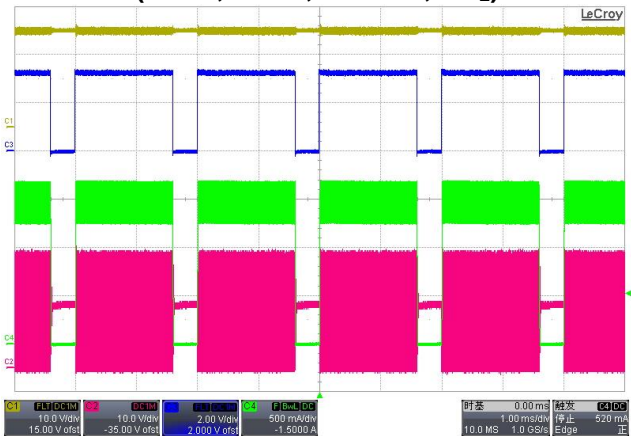

Functional Waveforms

PWM Dimming waveform(Vin=20V, 3LEDs)
(PWM frequency=500Hz, Duty=50%)
(Y-Vin, R-SW, B-VSET, G-I_L)

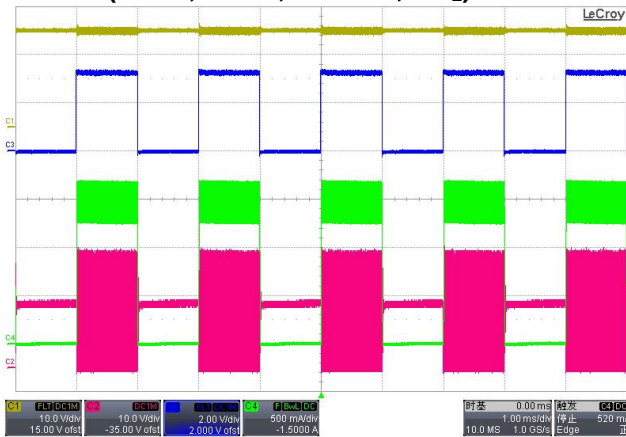

PWM Dimming waveform(Vin=20V, 3LEDs)
(PWM frequency=500Hz, Duty=20%)
(Y-Vin, R-SW, B-VSET, G-I_L)

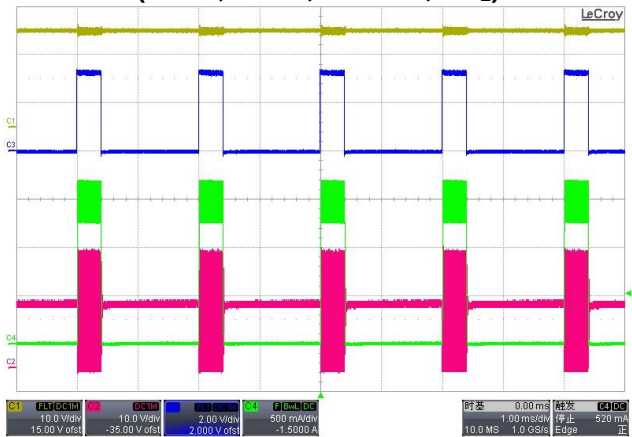

LED open protection(Vin=20V, 3LEDs)
(Y-Vin, R-SW, B-VSET, G-I_L)



LED short protection(Vin=20V, 3LEDs)
(Y-Vin, R-SW, B-LED K, G-I_L)

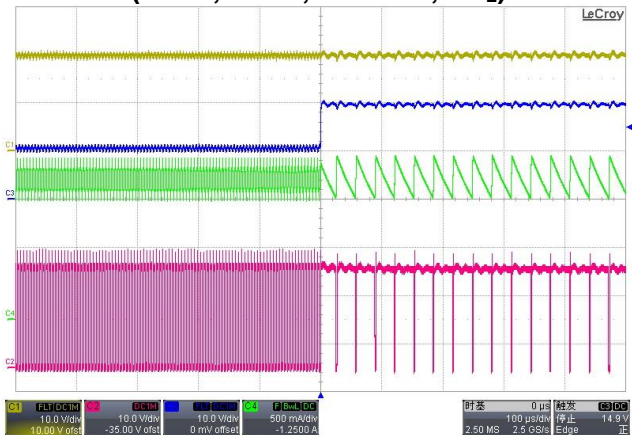

Functional Data Curves

Efficiency vs. Input Voltage

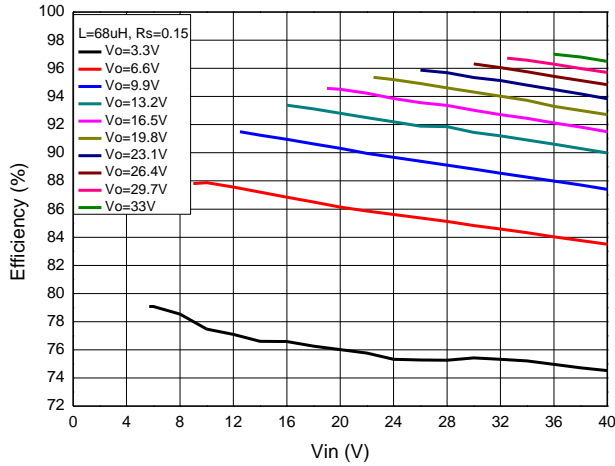

LED Current vs. Input Voltage

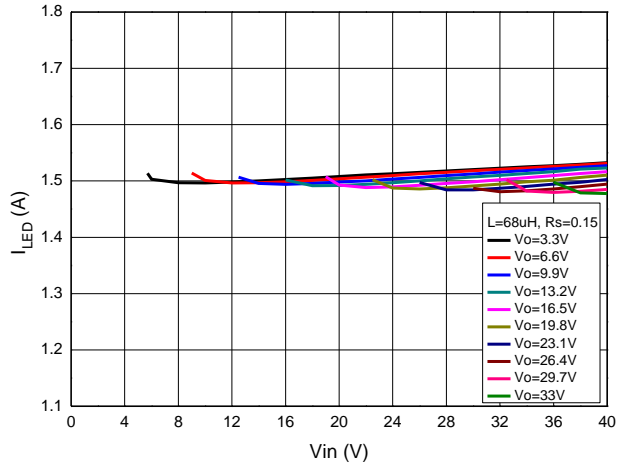

Operating Frequency vs. Input Voltage

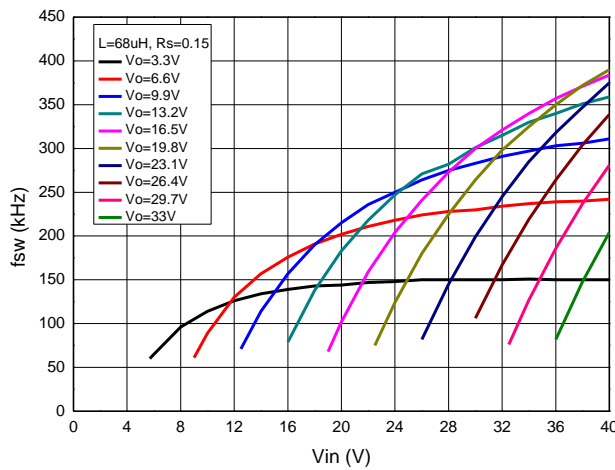

PWM Dimming (Vin=20V, 3LEDs)

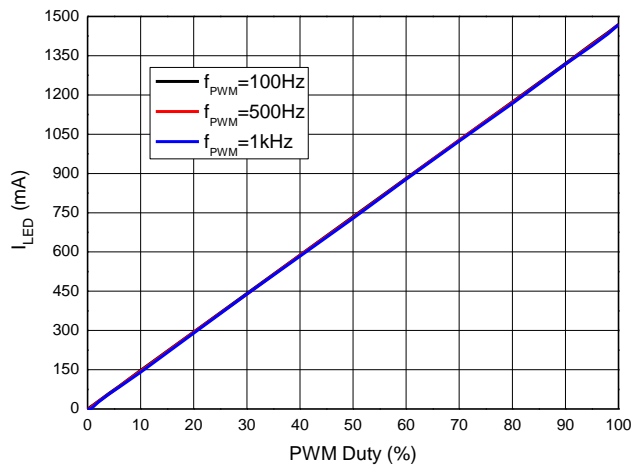

Analog Dimming (Vin=20V, 3LEDs)

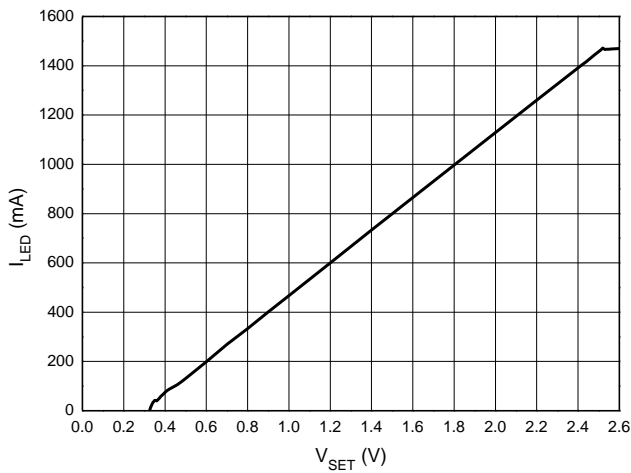

IMPORTANT NOTICE

1. DIODES INCORPORATED AND ITS SUBSIDIARIES ("DIODES") MAKE NO WARRANTY OF ANY KIND, EXPRESS OR IMPLIED, WITH REGARDS TO ANY INFORMATION CONTAINED IN THIS DOCUMENT, INCLUDING, BUT NOT LIMITED TO, THE IMPLIED WARRANTIES OF MERCHANTABILITY, FITNESS FOR A PARTICULAR PURPOSE OR NON-INFRINGEMENT OF THIRD PARTY INTELLECTUAL PROPERTY RIGHTS (AND THEIR EQUIVALENTS UNDER THE LAWS OF ANY JURISDICTION).
2. The Information contained herein is for informational purpose only and is provided only to illustrate the operation of Diodes products described herein and application examples. Diodes does not assume any liability arising out of the application or use of this document or any product described herein. This document is intended for skilled and technically trained engineering customers and users who design with Diodes products. Diodes products may be used to facilitate safety-related applications; however, in all instances customers and users are responsible for (a) selecting the appropriate Diodes products for their applications, (b) evaluating the suitability of the Diodes products for their intended applications, (c) ensuring their applications, which incorporate Diodes products, comply the applicable legal and regulatory requirements as well as safety and functional-safety related standards, and (d) ensuring they design with appropriate safeguards (including testing, validation, quality control techniques, redundancy, malfunction prevention, and appropriate treatment for aging degradation) to minimize the risks associated with their applications.
3. Diodes assumes no liability for any application-related information, support, assistance or feedback that may be provided by Diodes from time to time. Any customer or user of this document or products described herein will assume all risks and liabilities associated with such use, and will hold Diodes and all companies whose products are represented herein or on Diodes' websites, harmless against all damages and liabilities.
4. Products described herein may be covered by one or more United States, international or foreign patents and pending patent applications. Product names and markings noted herein may also be covered by one or more United States, international or foreign trademarks and trademark applications. Diodes does not convey any license under any of its intellectual property rights or the rights of any third parties (including third parties whose products and services may be described in this document or on Diodes' website) under this document.
5. Diodes products are provided subject to Diodes' Standard Terms and Conditions of Sale (<https://www.diodes.com/about/company/terms-and-conditions/terms-and-conditions-of-sales/>) or other applicable terms. This document does not alter or expand the applicable warranties provided by Diodes. Diodes does not warrant or accept any liability whatsoever in respect of any products purchased through unauthorized sales channel.
6. Diodes products and technology may not be used for or incorporated into any products or systems whose manufacture, use or sale is prohibited under any applicable laws and regulations. Should customers or users use Diodes products in contravention of any applicable laws or regulations, or for any unintended or unauthorized application, customers and users will (a) be solely responsible for any damages, losses or penalties arising in connection therewith or as a result thereof, and (b) indemnify and hold Diodes and its representatives and agents harmless against any and all claims, damages, expenses, and attorney fees arising out of, directly or indirectly, any claim relating to any noncompliance with the applicable laws and regulations, as well as any unintended or unauthorized application.
7. While efforts have been made to ensure the information contained in this document is accurate, complete and current, it may contain technical inaccuracies, omissions and typographical errors. Diodes does not warrant that information contained in this document is error-free and Diodes is under no obligation to update or otherwise correct this information. Notwithstanding the foregoing, Diodes reserves the right to make modifications, enhancements, improvements, corrections or other changes without further notice to this document and any product described herein. This document is written in English but may be translated into multiple languages for reference. Only the English version of this document is the final and determinative format released by Diodes.
8. Any unauthorized copying, modification, distribution, transmission, display or other use of this document (or any portion hereof) is prohibited. Diodes assumes no responsibility for any losses incurred by the customers or users or any third parties arising from any such unauthorized use.

Copyright © 2021 Diodes Incorporated

www.diodes.com