

General Description

The AL5816 is a 5-terminal adjustable constant current linear LED controller offering excellent temperature stability and current capability. It can work with a wide input voltage range from 4.5V to 60V. With its low 200mV current sense FB voltage, it controls the regulation of LED current with minimum power dissipation compared with traditional linear LED drivers. This makes it ideal for medium to high current LEDs.

The device has an internal output drive up to 15mA, which enables it to drive external bipolar transistors or MOSFETs. It also provides the capability to drive longer LED chains with low drop out voltage and multiple LED channels.

AL5816 has the LED current adjusted and controlled by a sense resistor connected across FB pin and GND. The voltage across this resistor is controlled to a precise 0.2V thus controlling the current.

The average LED current can be adjusted by applying a high frequency PWM signal higher than 200Hz to the PWM pin.

AL5816 is available in SOT25 package.

Applications

- Commercial and Industrial Lighting
- Exterior Lighting
- Appliance Lights

Key Features

- Wide Input Voltage Range from 4.5V to 60V
- Low Reference Voltage (VFB = 0.2V)
- 3% Reference Voltage Tolerance over Temperature
- Up to 15mA Driver Capability for Bipolar Transistor
- PWM dimming frequency higher than 200Hz
- Input Under Voltage Lock-out
- Over Temperature Shutdown

Due to similar function, AL5815 and AL5816 have the same evaluation board, please check the identification code on U1 to ensure get the right device. Or check the white mark which is not painted with black ink on the PCB, refer to Figure 2.

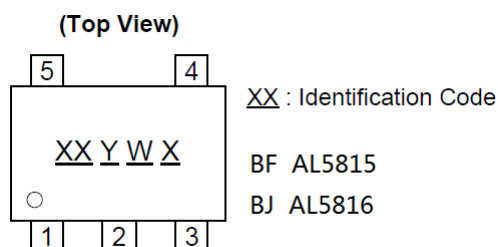

Figure 1: Marking information

AL5816EV1 Specifications

Parameter	Value
Input Voltage	4.5~60Vdc
LED Current	1A
Number of LEDs	1~17pcs
XYZ Dimension	63.3mm x 40mm x 10mm

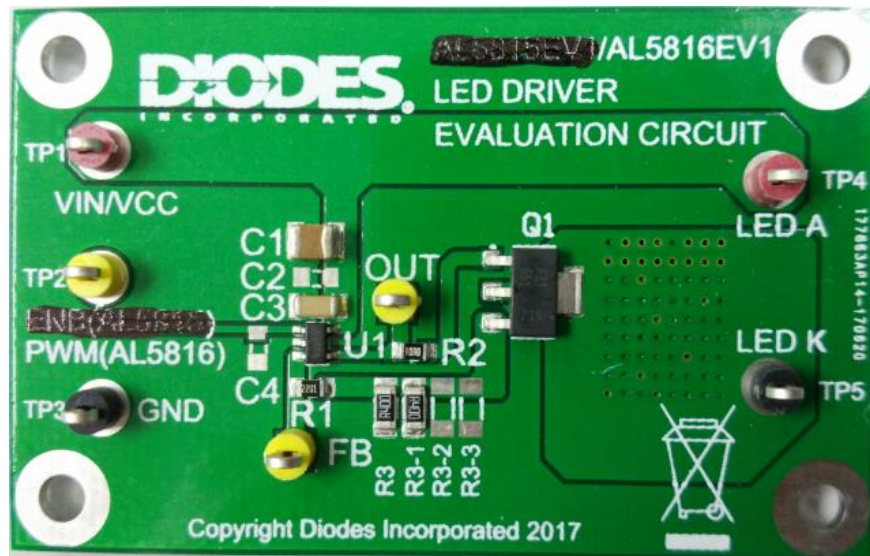

Figure 2: Top View

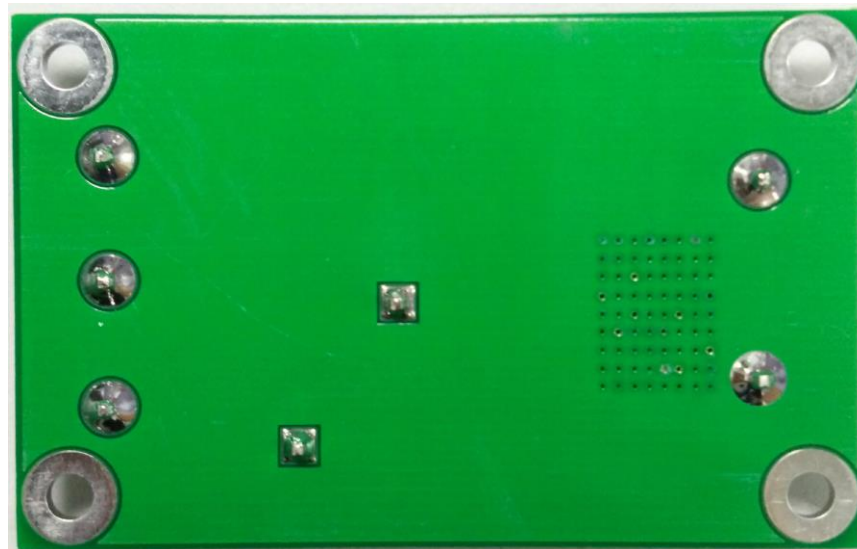

Figure 3: Bottom View

Connection Instructions

Power Supply Input: 4.5~60VDC (VIN, GND)

External LED connection: LED A is for LEDs string anode, and LED K is for cathode

PWM dimming signal input (PWM, GND): Floating and high/ON, low/OFF

Evaluation Board Schematic

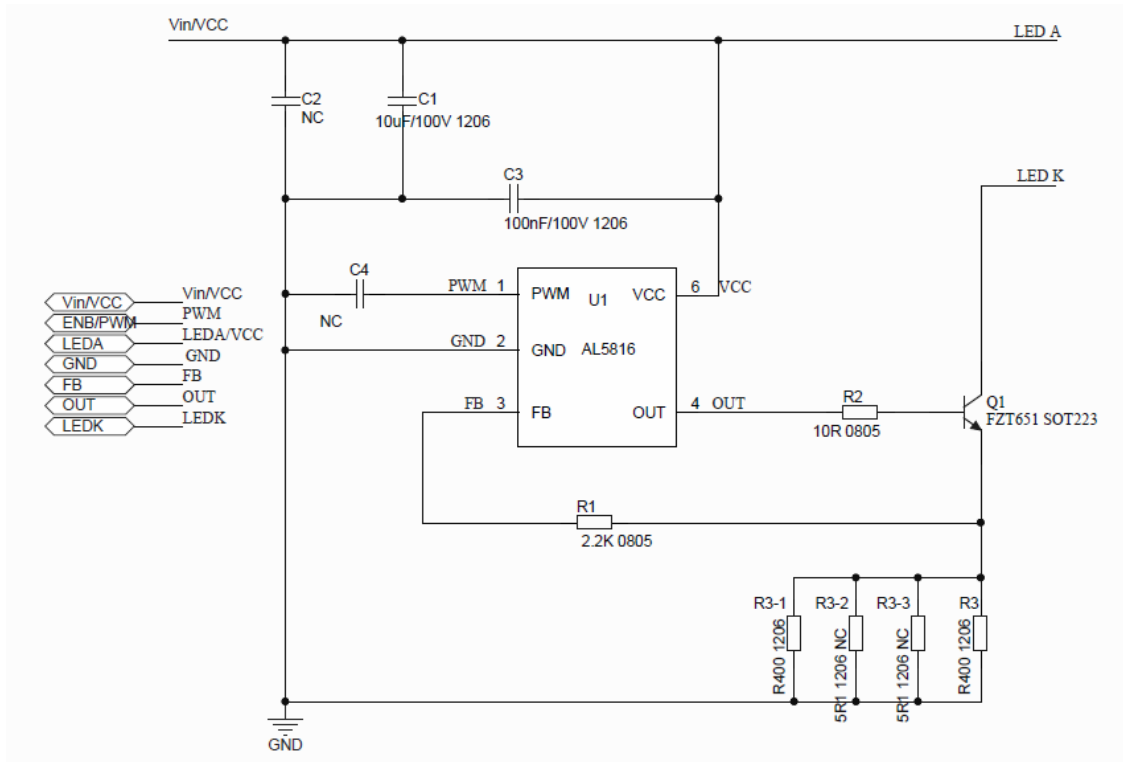

Figure 4: Evaluation Board Schematic

Evaluation Board Layout

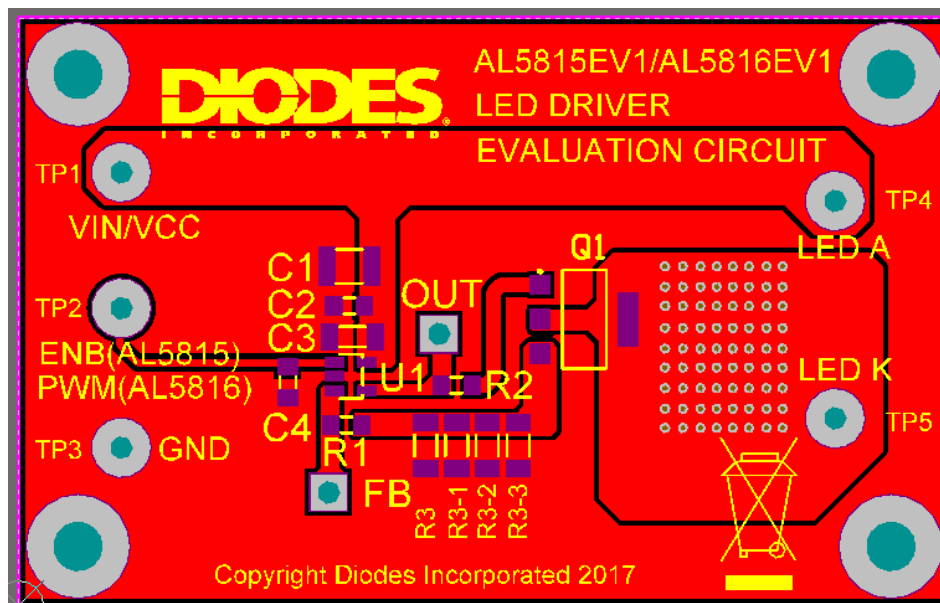

Figure 5: PCB Board Layout Top View

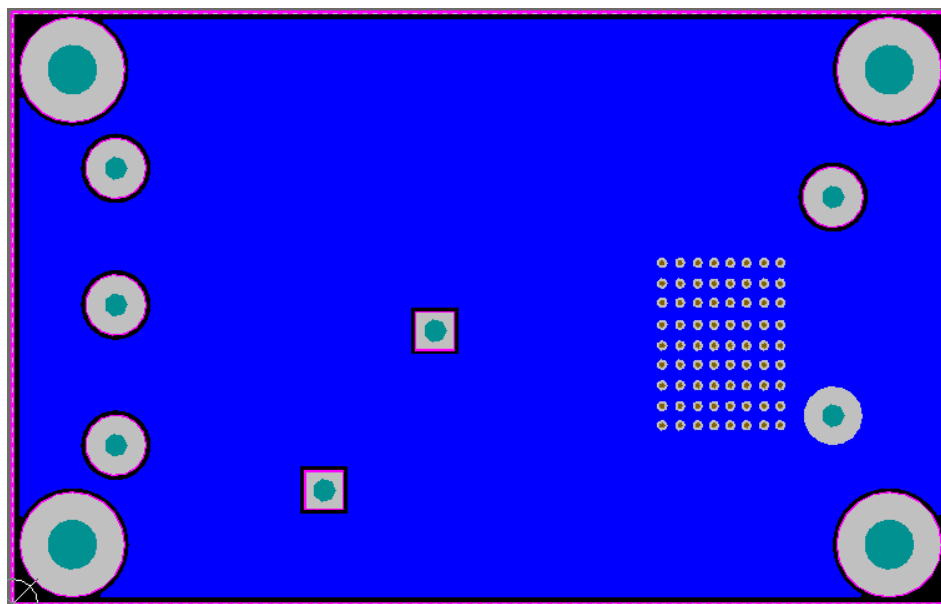

Figure 6: PCB Board Layout Bottom View

Quick Start Guide

1. By default, the LED current of evaluation board is preset at 1A.
2. Ensure that the DC source is switched OFF or disconnected.
3. Connect the anode wire of external LED string to LED A of the evaluation board.
4. Connect the cathode wire of external LED string to LED K of the evaluation board.
5. Connect two DC line wires to the VIN and GND terminals on the evaluation board.
6. Ensure that the area around the board is clear and safe, and preferably that the board and LEDs are enclosed in a transparent safety cover.
7. Turn on the main switch. LED string should light up with LED.

Bill of Material

Item	Description	Package
C1	Ceramic Cap,10uF/100V, X7R, murata	1210
C2	NC	NC
C3	Ceramic Cap,0.1uF/100V, X7R, murata	1206
C4	NC	NC
Q1	FZT651TA, 60V/3A, NPN Transistor, Diodes Inc.	SOT223
R1	SMD Resistor, 2.2K, 5%, 1/8W	0805
R2	SMD Resistor, 10R, 5%, 1/8W	0805
R3	SMD Resistor, R400, 1%, 1/4W	1206
R3-1	SMD Resistor, R400, 1%, 1/4W	1206
R3-2	NC	NC
R3-3	NC	NC
U1	AL5816, Diodes Inc.	SOT25

Functional Performance

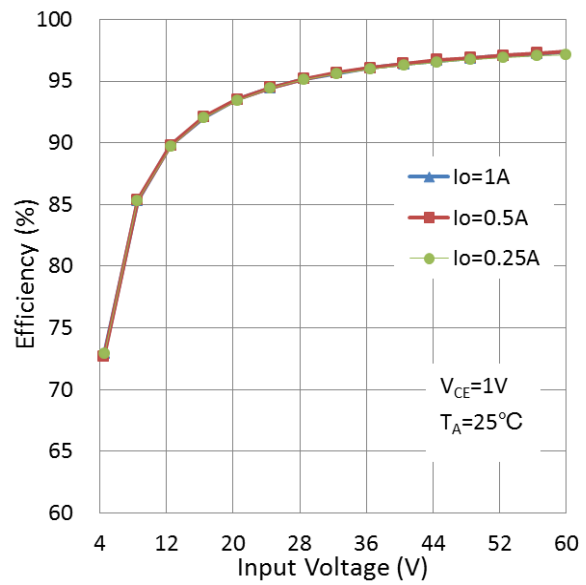
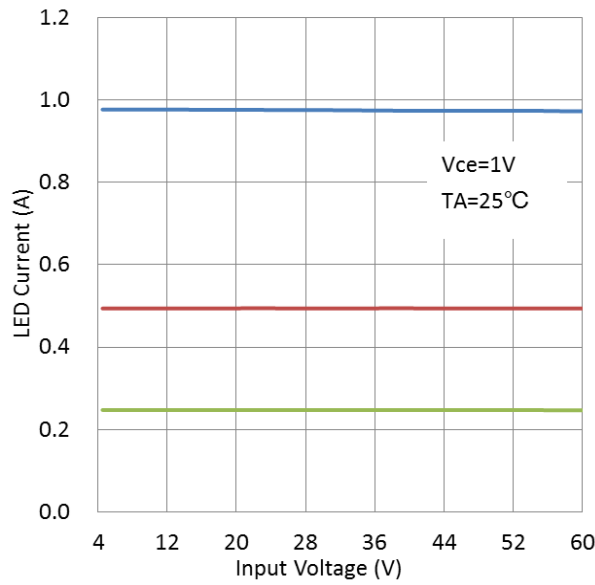

Dimming curve

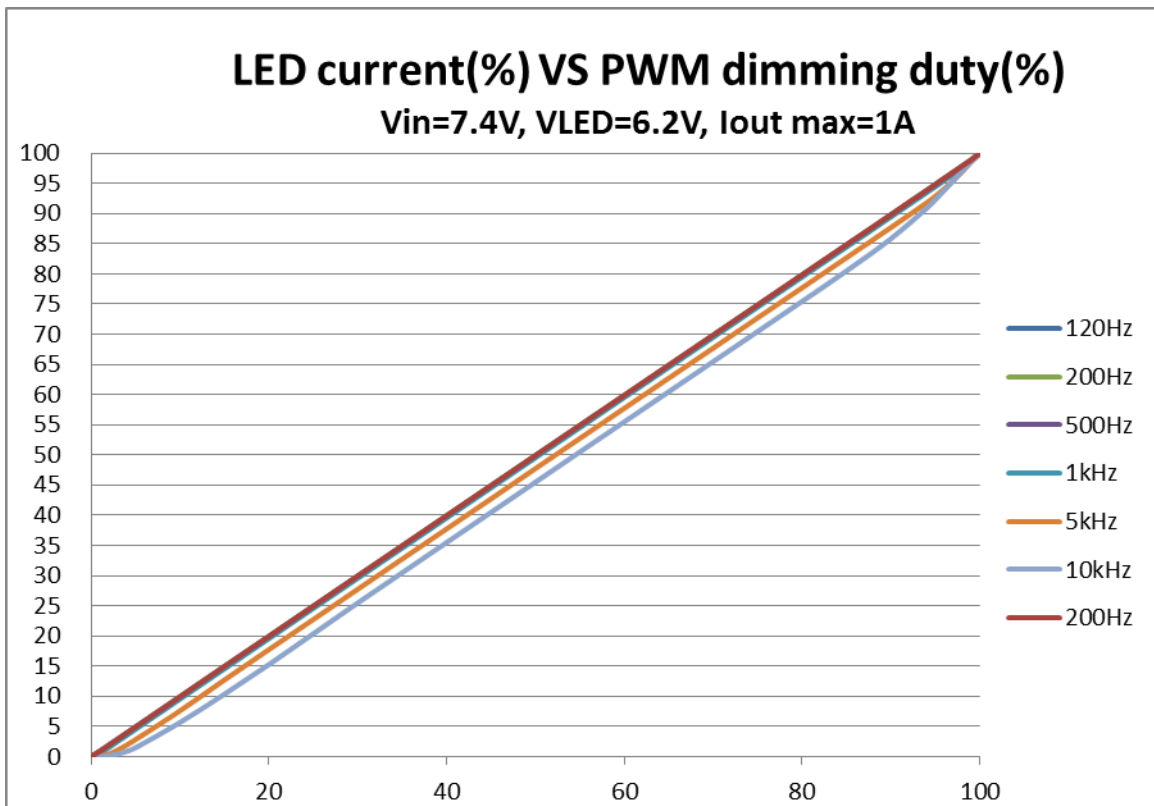

Dimming Waveform

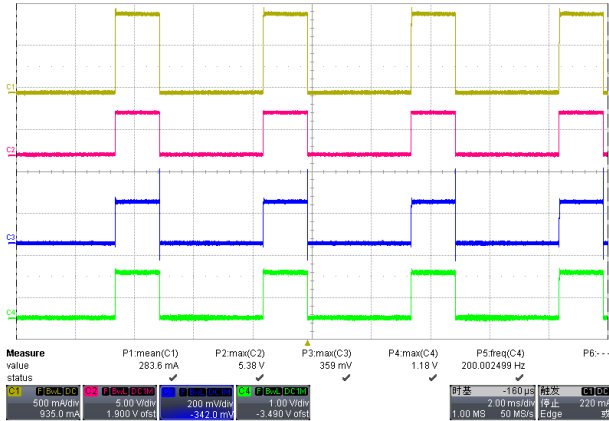
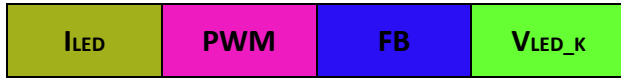

Frequency=200Hz, duty=30%

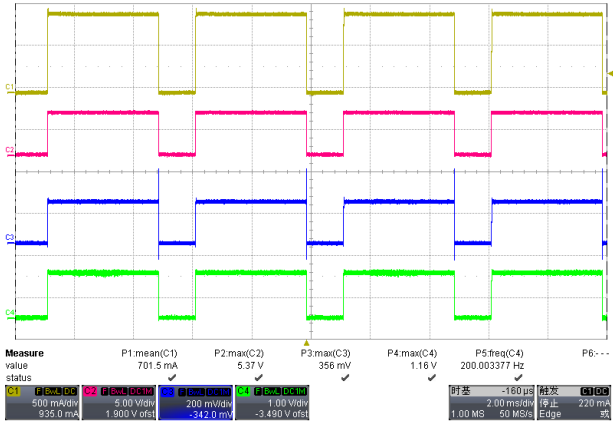

Frequency=200Hz, duty=70%

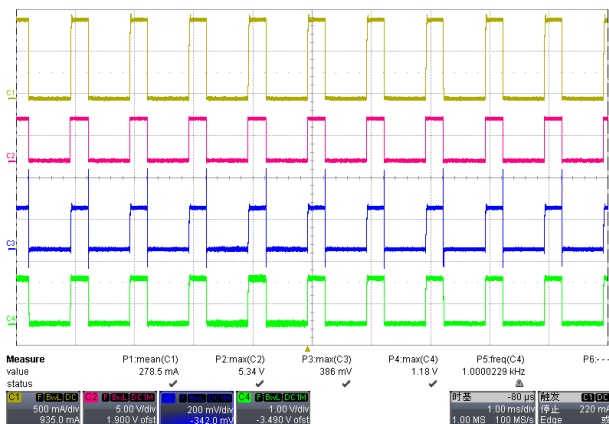

Frequency=1kHz, duty=30%

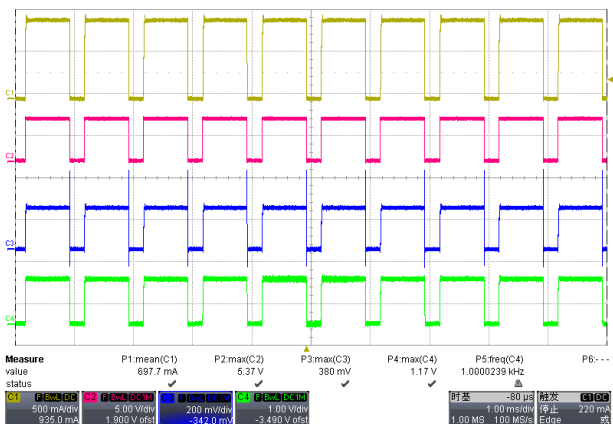

Frequency=1kHz, duty=70%

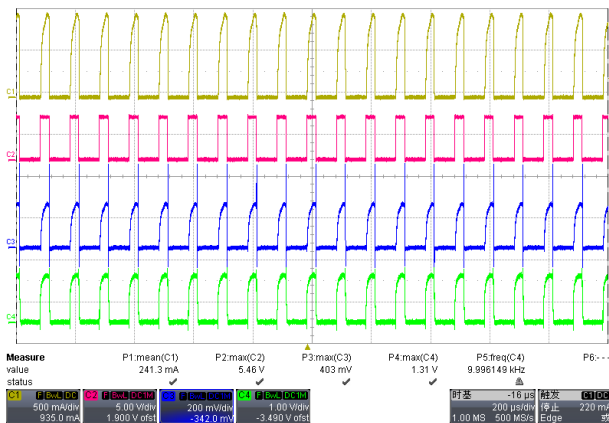

Frequency=10kHz, duty=30%

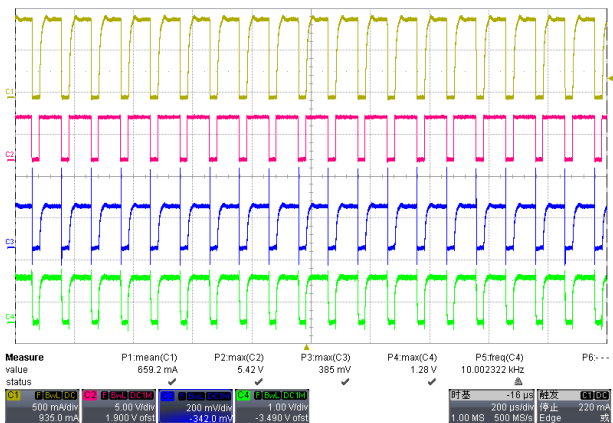

Frequency=10kHz, duty=70%

Startup sequence

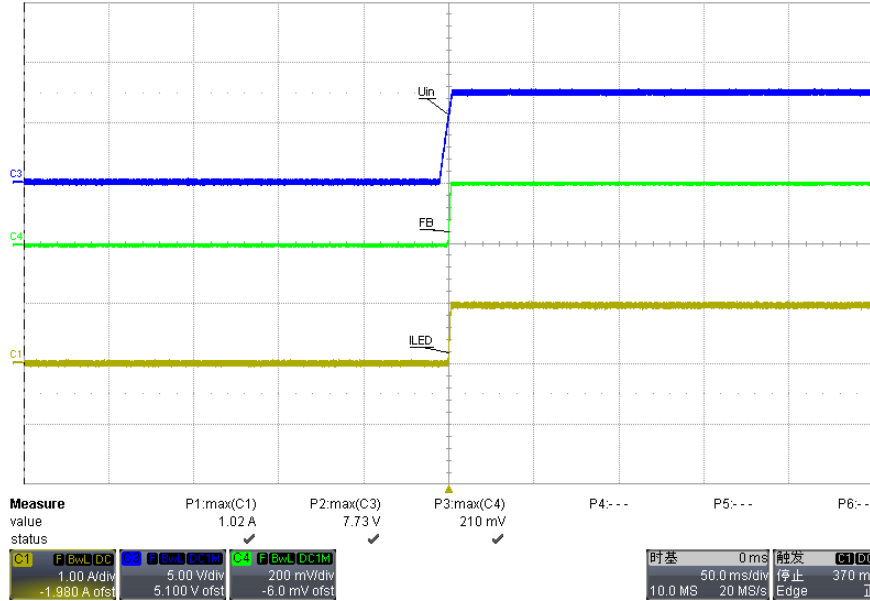

Vout=6.2V, Vin=7.4V, Iout=1A

IMPORTANT NOTICE

DIODES INCORPORATED MAKES NO WARRANTY OF ANY KIND, EXPRESS OR IMPLIED, WITH REGARDS TO THIS DOCUMENT, INCLUDING, BUT NOT LIMITED TO, THE IMPLIED WARRANTIES OF MERCHANTABILITY AND FITNESS FOR A PARTICULAR PURPOSE (AND THEIR EQUIVALENTS UNDER THE LAWS OF ANY JURISDICTION).

Diodes Incorporated and its subsidiaries reserve the right to make modifications, enhancements, improvements, corrections or other changes without further notice to this document and any product described herein. Diodes Incorporated does not assume any liability arising out of the application or use of this document or any product described herein; neither does Diodes Incorporated convey any license under its patent or trademark rights, nor the rights of others. Any Customer or user of this document or products described herein in such applications shall assume all risks of such use and will agree to hold Diodes Incorporated and all the companies whose products are represented on Diodes Incorporated website, harmless against all damages.

Diodes Incorporated does not warrant or accept any liability whatsoever in respect of any products purchased through unauthorized sales channel.

Should Customers purchase or use Diodes Incorporated products for any unintended or unauthorized application, Customers shall indemnify and hold Diodes Incorporated and its representatives harmless against all claims, damages, expenses, and attorney fees arising out of, directly or indirectly, any claim of personal injury or death associated with such unintended or unauthorized application.

Products described herein may be covered by one or more United States, international or foreign patents pending. Product names and markings noted herein may also be covered by one or more United States, international or foreign trademarks.

LIFE SUPPORT

Diodes Incorporated products are specifically not authorized for use as critical components in life support devices or systems without the express written approval of the Chief Executive Officer of Diodes Incorporated. As used herein:

A. Life support devices or systems are devices or systems which:

1. are intended to implant into the body, or
2. support or sustain life and whose failure to perform when properly used in accordance with instructions for use provided in the labeling can be reasonably expected to result in significant injury to the user.

B. A critical component is any component in a life support device or system whose failure to perform can be reasonably expected to cause the failure of the life support device or to affect its safety or effectiveness.

Customers represent that they have all necessary expertise in the safety and regulatory ramifications of their life support devices or systems, and acknowledge and agree that they are solely responsible for all legal, regulatory and safety-related requirements concerning their products and any use of Diodes Incorporated products in such safety-critical, life support devices or systems, notwithstanding any devices- or systems-related information or support that may be provided by Diodes Incorporated. Further, Customers must fully indemnify Diodes Incorporated and its representatives against any damages arising out of the use of Diodes Incorporated products in such safety-critical, life support devices or systems.

Copyright © 2017, Diodes Incorporated

www.diodes.com